

# Dell B2360d-dn Laser Printer

## User's Guide



**March 2014**

**[www.dell.com](http://www.dell.com) | [dell.com/support/printers](http://dell.com/support/printers)**

---

#### **Trademarks**

Information in this document is subject to change without notice.

© 2014 Dell, Inc. All rights reserved.

Reproduction of this material in any manner whatsoever without the written permission of Dell Inc. is strictly forbidden.

Trademarks used in this text: *Dell*, the *DELL* logo, *Inspiron*, *Dell Precision*, *Dimension*, *OptiPlex*, *Latitude*, *PowerEdge*, *PowerVault*, *PowerApp*, and *Dell OpenManage* are trademarks of Dell Inc.; *Intel*, *Pentium*, and *Celeron* are registered trademarks of Intel Corporation; *Microsoft* and *Windows* are registered trademarks of Microsoft Corporation; *AirPrint* and the *AirPrint* logo are trademarks of Apple, Inc.

Other trademarks and trade names may be used in this document to refer to the entities claiming the marks and names of their products. Dell Inc. disclaims any proprietary interest in trademarks and trade names other than its own.

# Contents

- Safety information.....5**
- Learning about the printer.....7**
  - Finding information about the printer.....7
  - Selecting a location for the printer.....8
  - Printer configurations.....9
  - Using the printer control panel.....11
  - Understanding the colors of the Sleep button and indicator lights.....12
  - Using the Embedded Web Server.....12
  - Using the Local Printer Settings Utility.....13
- Additional printer setup.....14**
  - Installing internal options.....14
  - Installing hardware options.....17
  - Attaching cables.....18
  - Setting up the printer software.....19
  - Networking.....20
  - Verifying printer setup.....24
- Loading paper and specialty media.....26**
  - Setting the paper size and type.....26
  - Configuring Universal paper settings.....26
  - Using the standard bin and paper stop.....27
  - Loading trays.....27
  - Loading the multipurpose feeder.....32
  - Linking and unlinking trays.....35
- Paper and specialty media guide.....38**
  - Paper guidelines.....38
  - Using specialty media.....41
  - Storing paper.....43
  - Supported paper sizes, types, and weights.....43
- Printing.....46**
  - Printing a document.....46

Printing from a mobile device.....	47
Printing information pages.....	48
Canceling a print job.....	48
<b>Understanding the printer menus.....</b>	<b>49</b>
Menus list.....	49
Paper menu.....	49
Reports menu.....	58
Network/Ports menu.....	59
Security menu.....	66
Settings menu.....	68
<b>Saving money and the environment.....</b>	<b>80</b>
Saving paper and toner.....	80
Saving energy.....	80
Recycling.....	83
<b>Securing the printer.....</b>	<b>84</b>
Using the security lock feature.....	84
Statement of Volatility.....	84
Erasing volatile memory.....	85
Erasing non-volatile memory.....	85
Finding printer security information.....	85
<b>Maintaining the printer.....</b>	<b>86</b>
Cleaning the printer.....	86
Checking the status of parts and supplies.....	86
Estimated number of remaining pages.....	87
Ordering supplies.....	87
Storing supplies.....	87
Replacing supplies.....	88
Moving the printer.....	92
<b>Managing the printer.....</b>	<b>93</b>
Managing printer messages.....	93
Accessing Status Monitor Center.....	93
Accessing the remote control panel.....	93
Viewing reports.....	94

---

Configuring supply notifications from the Embedded Web Server.....	94
Copying printer settings to other printers.....	95
Restoring factory default settings.....	95
Creating a printer control panel PIN.....	96
<b>Clearing jams.....</b>	<b>97</b>
Avoiding jams.....	97
Understanding jam messages and locations.....	98
Jam, front door [20y.xx].....	99
Jam, rear door [20y.xx].....	102
Jam, standard bin [20y.xx].....	103
Jam, pull tray 1. Push down blue flap. [23y.xx].....	104
Jam, tray [x] [24y.xx].....	106
Jam, MP feeder [250.xx].....	106
<b>Troubleshooting.....</b>	<b>108</b>
Understanding the printer messages.....	108
Solving printer problems.....	116
Solving print problems.....	122
Embedded Web Server does not open.....	144
Contacting technical support.....	145
<b>Appendix.....</b>	<b>146</b>
<b>Index.....</b>	<b>148</b>

## Safety information

Connect the power cord to a properly grounded electrical outlet that is near the product and easily accessible.

Do not place or use this product near water or wet locations.

 **CAUTION—POTENTIAL INJURY:** This product uses a laser. Use of controls or adjustments or performance of procedures other than those specified herein may result in hazardous radiation exposure.

This product uses a printing process that heats the print media, and the heat may cause the media to release emissions. You must understand the section in your operating instructions that discusses the guidelines for selecting print media to avoid the possibility of harmful emissions.

 **CAUTION—POTENTIAL INJURY:** The lithium battery in this product is not intended to be replaced. There is a danger of explosion if a lithium battery is incorrectly replaced. Do not recharge, disassemble, or incinerate a lithium battery. Discard used lithium batteries according to the manufacturer's instructions and local regulations.

 **CAUTION—POTENTIAL INJURY:** Before moving the printer, follow these guidelines to avoid personal injury or printer damage:

- Turn the printer off using the power switch, and then unplug the power cord from the electrical outlet.
- Disconnect all cords and cables from the printer before moving it.
- If an optional tray is installed, then remove it from the printer. To remove the optional tray, slide the latch on the right side of the tray toward the front of the tray until it *clicks* into place.
- Use the handholds located on both sides of the printer to lift it.
- Make sure your fingers are not under the printer when you set it down.
- Before setting up the printer, make sure there is adequate clearance around it.

Use only the power cord provided with this product or the manufacturer's authorized replacement.

 **CAUTION—HOT SURFACE:** The inside of the printer might be hot. To reduce the risk of injury from a hot component, allow the surface to cool before touching it.

 **CAUTION—SHOCK HAZARD:** If you are accessing the controller board or installing optional hardware or memory devices sometime after setting up the printer, then turn the printer off, and unplug the power cord from the electrical outlet before continuing. If you have any other devices attached to the printer, then turn them off as well, and unplug any cables going into the printer.

 **CAUTION—SHOCK HAZARD:** Make sure that all external connections (such as Ethernet and telephone system connections) are properly installed in their marked plug-in ports.

This product is designed, tested, and approved to meet strict global safety standards with the use of specific manufacturer's components. The safety features of some parts may not always be obvious. The manufacturer is not responsible for the use of other replacement parts.

 **CAUTION—POTENTIAL INJURY:** Do not cut, twist, bind, crush, or place heavy objects on the power cord. Do not subject the power cord to abrasion or stress. Do not pinch the power cord between objects such as furniture and walls. If any of these things happen, a risk of fire or electrical shock results. Inspect the power cord regularly for signs of such problems. Remove the power cord from the electrical outlet before inspecting it.

Refer service or repairs, other than those described in the user documentation, to a service representative.

 **CAUTION—SHOCK HAZARD:** To avoid the risk of electrical shock when cleaning the exterior of the printer, unplug the power cord from the electrical outlet and disconnect all cables from the printer before proceeding.

 **CAUTION—POTENTIAL INJURY:** To reduce the risk of equipment instability, load each tray separately. Keep all other trays closed until needed.

 **CAUTION—SHOCK HAZARD:** Do not set up this product or make any electrical or cabling connections, such as the fax feature, power cord, or telephone, during a lightning storm.

**SAVE THESE INSTRUCTIONS.**

# Learning about the printer

## Finding information about the printer

What are you looking for?	Find it here
Initial setup instructions: <ul style="list-style-type: none"> <li>• Connecting the printer</li> <li>• Installing the printer software</li> </ul>	Setup documentation—The setup documentation came with the printer.
Additional setup and instructions for using the printer: <ul style="list-style-type: none"> <li>• Selecting and storing paper and specialty media</li> <li>• Loading paper</li> <li>• Configuring printer settings</li> <li>• Viewing and printing documents and photos</li> <li>• Setting up and using the printer software</li> <li>• Configuring the printer on a network</li> <li>• Caring for and maintaining the printer</li> <li>• Troubleshooting and solving problems</li> </ul>	<i>User's Guide</i> and <i>Quick Reference Guide</i> —The guides may be available on the <i>Software and Documentation</i> CD. For more information, visit our Web site at <a href="http://www.dell.com/support/manuals">www.dell.com/support/manuals</a> .
Instructions for: <ul style="list-style-type: none"> <li>• Connecting the printer to an Ethernet network</li> <li>• Troubleshooting printer connection problems</li> </ul>	<i>Networking Guide</i> —Open the <i>Software and Documentation</i> CD, and then navigate to: <b>Documentation &gt; User's Guide and other publications &gt; Networking Guide</b>
Help using the printer software	Windows or Mac Help—Open a printer software program or application, and then click <b>Help</b> .  Click  to view context-sensitive information.  <b>Notes:</b> <ul style="list-style-type: none"> <li>• Help is automatically installed with the printer software.</li> <li>• The printer software is located in the printer program folder or on the desktop, depending on your operating system.</li> </ul>
The latest supplemental information, updates, and technical support: <ul style="list-style-type: none"> <li>• Documentation</li> <li>• Driver downloads</li> <li>• Product upgrades</li> <li>• Service call and repair information</li> <li>• Order status</li> <li>• Live chat support</li> <li>• E-mail support</li> <li>• Voice support</li> </ul>	Dell support Web site— <a href="http://www.dell.com/support/printers">www.dell.com/support/printers</a>  Support telephone numbers and hours of operation for your country or region can be found on the support Web site.  Have the following information ready when you contact support so that they may serve you faster: <ul style="list-style-type: none"> <li>• Service tag</li> <li>• Express service Code</li> </ul> <b>Note:</b> The service tag and express service code appear on labels located on your printer.

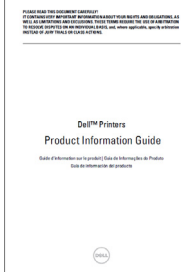
What are you looking for?	Find it here
<ul style="list-style-type: none"> <li>• Software and Drivers—Certified drivers for your printer and installers for Dell printer software</li> <li>• Readme files—Last-minute technical changes, or advanced technical reference materials for experienced users or technicians</li> </ul>	<p><i>Software and Documentation CD</i></p>
<ul style="list-style-type: none"> <li>• Supplies and accessories for your printer</li> <li>• Replacement cartridges</li> </ul>	<p>Dell printer supplies Web site—<a href="http://www.dell.com/printers">www.dell.com/printers</a> You can purchase printer supplies online, by telephone, or in select retail stores.</p>
<ul style="list-style-type: none"> <li>• Safety information for preparing to operate your printer</li> <li>• Regulatory information</li> <li>• Warranty information</li> </ul>	<p><i>Product Information Guide</i></p>  <p><b>Note:</b> The <i>Product Information Guide</i> may not be available in your country or region.</p>

## Selecting a location for the printer

When selecting a location for the printer, leave enough room to open trays, covers, and doors. If you plan to install any hardware options, then leave enough room for them also. It is important to:

- Set up the printer near a properly grounded and easily accessible electrical outlet.
- Make sure airflow in the room meets the latest revision of the ASHRAE 62 standard or the CEN Technical Committee 156 standard.
- Provide a flat, sturdy, and stable surface.
- Keep the printer:
  - Clean, dry, and free of dust.
  - Away from stray staples and paper clips.
  - Away from the direct airflow of air conditioners, heaters, or ventilators.
  - Free from direct sunlight and humidity extremes.
- Observe the recommended temperatures and avoid fluctuations.

Ambient temperature	16 to 32°C (60 to 90°F)
Storage temperature	-20 to 40°C (-4 to 104°F)

- Allow the following recommended amount of space around the printer for proper ventilation:



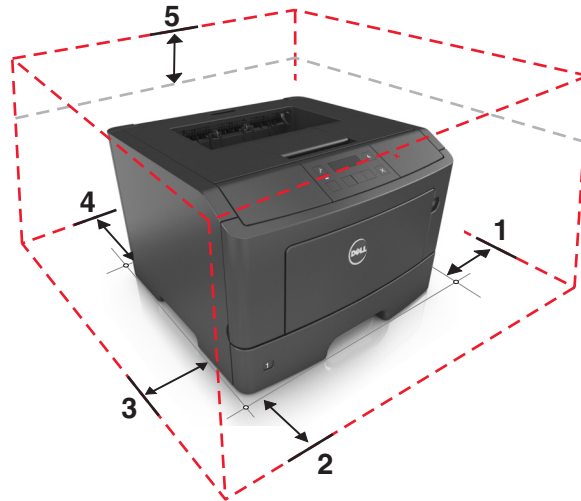

1	Right side	300 mm (12 in.)
2	Front	510 mm (20 in.)
3	Left side	200 mm (8 in.)
4	Rear	200 mm (8 in.)
5	Top	300 mm (12 in.)

## Printer configurations

**⚠ CAUTION—POTENTIAL INJURY:** To reduce the risk of equipment instability, load each tray separately. Keep all other trays closed until needed.

You can configure your printer by adding one optional 550-sheet tray. For instructions on installing the optional tray, see [“Installing optional trays” on page 17](#).

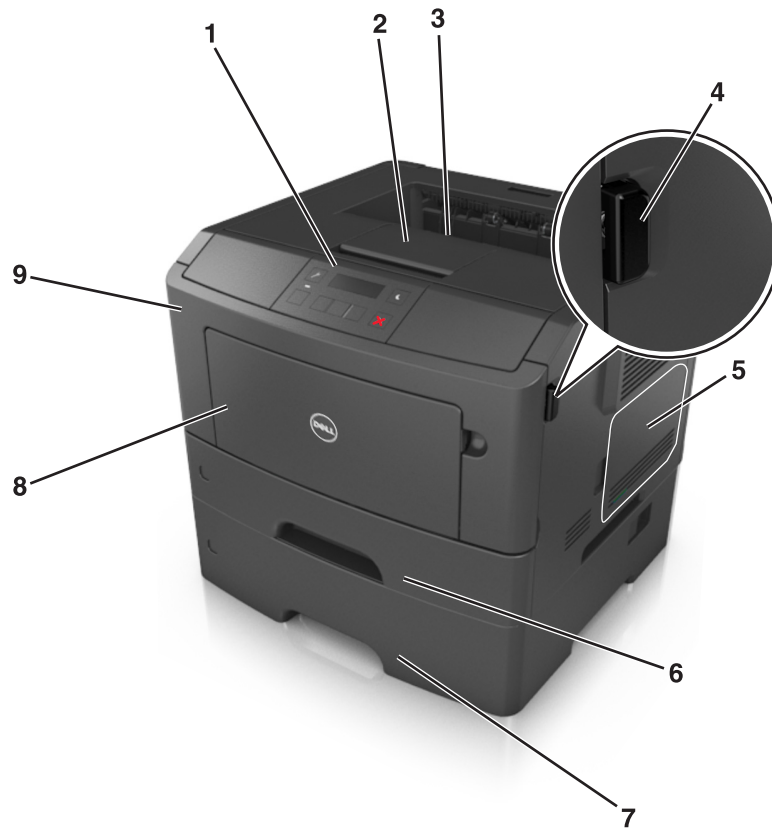

1	Printer control panel
2	Paper stop
3	Standard bin
4	Front door release button
5	Controller board access door
6	Standard 250-sheet tray
7	Optional 550-sheet tray <b>Note:</b> A lockable 550-sheet tray is also available. For more information, contact the place where you purchased the printer.
8	50-sheet multipurpose feeder
9	Front door

## Using the printer control panel

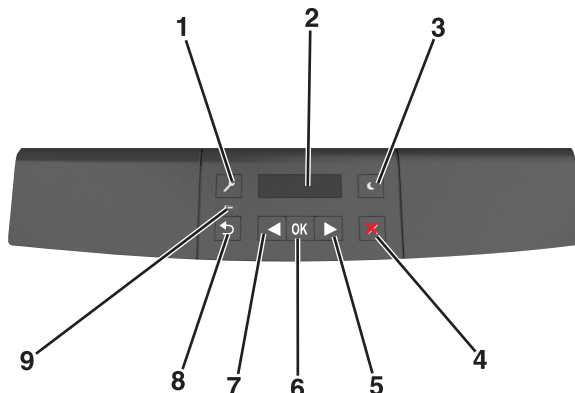

	Use the	To
1	Menus button	Open the menus. <b>Notes:</b> <ul style="list-style-type: none"> <li>The menus are available only when the printer is in the Ready state.</li> <li>Pressing the button while navigating within the menus returns the printer control panel to the top-level menu screen.</li> </ul>
2	Display	View printing options as well as status and error messages.
3	Sleep button	Enable Sleep mode or Hibernate mode. <b>Notes:</b> <ul style="list-style-type: none"> <li>Pressing any hard button will cause the printer to wake from Sleep mode.</li> <li>Pressing the Sleep button or the power switch will cause the printer to wake from Hibernate mode.</li> </ul>
4	Stop button	<ul style="list-style-type: none"> <li>Exit the menus and return to the Ready state.</li> <li>Stop printer activities, such as printing or downloading fonts.</li> </ul>
5	Right arrow button	<ul style="list-style-type: none"> <li>Scroll through menus or to move between screens and menu options.</li> <li>Scroll through settings or text. For menus with numeric values, press and hold an arrow button to scroll through the settings. Release the button when the value you want appears.</li> </ul>
6	Select button	<ul style="list-style-type: none"> <li>Open a menu.</li> <li>Display available values or settings for a menu. The current default setting is indicated by an asterisk (*).</li> <li>Save the displayed value as the new user default setting.</li> </ul>
7	Left arrow button	<ul style="list-style-type: none"> <li>Scroll through menus or to move between screens and menu options.</li> <li>Scroll through settings or text. For menus with numeric values, press and hold an arrow button to scroll through the settings. Release the button when the value you want appears.</li> </ul>
8	Back button	Return to the previous screen.
9	Indicator light	Determine the status of the printer.

## Understanding the colors of the Sleep button and indicator lights

The colors of the Sleep button and indicator lights on the printer control panel signify a certain printer status or condition.

Indicator light	Printer status
Off	The printer is off or in Hibernate mode.
Blinking green	The printer is warming up, processing data, or printing.
Solid green	The printer is on, but idle.
Blinking red	The printer requires user intervention.
Sleep button light	Printer status
Off	The printer is off, idle or in Ready state.
Solid amber	The printer is in Sleep mode.
Blinking amber	The printer is entering or waking from Hibernate mode.
Blinking amber for 0.1 second, then goes completely off for 1.9 seconds in a slow, pulsing pattern	The printer is in Hibernate mode.

## Using the Embedded Web Server

**Note:** This feature is available only in network printers or printers connected to print servers.

If the printer is installed on a network, then you can use the Embedded Web Server to do the following:

- View the virtual display of the printer control panel.
- Check the status of the printer supplies.
- Configure supply notifications.
- Configure printer settings.
- Configure network settings.
- View reports.

To access the Embedded Web Server for your printer:

**1** Obtain the printer IP address:

- From the TCP/IP section in the Network/Ports menu
- By printing a network setup page or menu settings page, and then finding the TCP/IP section

**Notes:**

- An IP address appears as four sets of numbers separated by periods, such as 123.123.123.123.
- If you are using a proxy server, then temporarily disable it to load the Web page correctly.

**2** Open a Web browser, and then type the printer IP address in the address field.

**3** Press **Enter**.

The Embedded Web Server page appears.

## Using the Local Printer Settings Utility

- 1 Access the Local Printer Settings Utility from the list of applications or the Start menu to adjust the printer settings.
- 2 Save the changes using the Actions menu.

**Note:** To distribute the settings to other printers, save the settings in a command file.

# Additional printer setup

## Installing internal options

**⚠ CAUTION—SHOCK HAZARD:** If you are accessing the controller board or installing optional hardware or memory devices sometime after setting up the printer, then turn the printer off, and unplug the power cord from the electrical outlet before continuing. If you have any other devices attached to the printer, then turn them off as well, and unplug any cables going into the printer.

## Available internal options

### Memory cards

- Flash memory
- Fonts

## Accessing the controller board

**⚠ CAUTION—SHOCK HAZARD:** If you are accessing the controller board or installing optional hardware or memory devices sometime after setting up the printer, then turn the printer off, and unplug the power cord from the electrical outlet before continuing. If you have any other devices attached to the printer, then turn them off as well, and unplug any cables going into the printer.

- 1 Open the controller board access door.

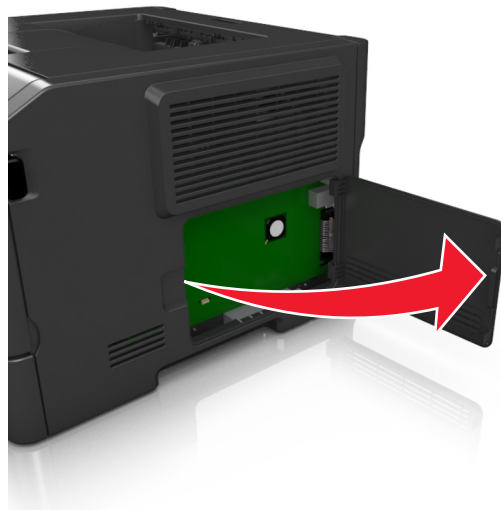

- 2 Locate the memory card connector.

**Warning—Potential Damage:** Controller board electronic components are easily damaged by static electricity. Touch a metal surface on the printer before touching any controller board electronic components or connectors.

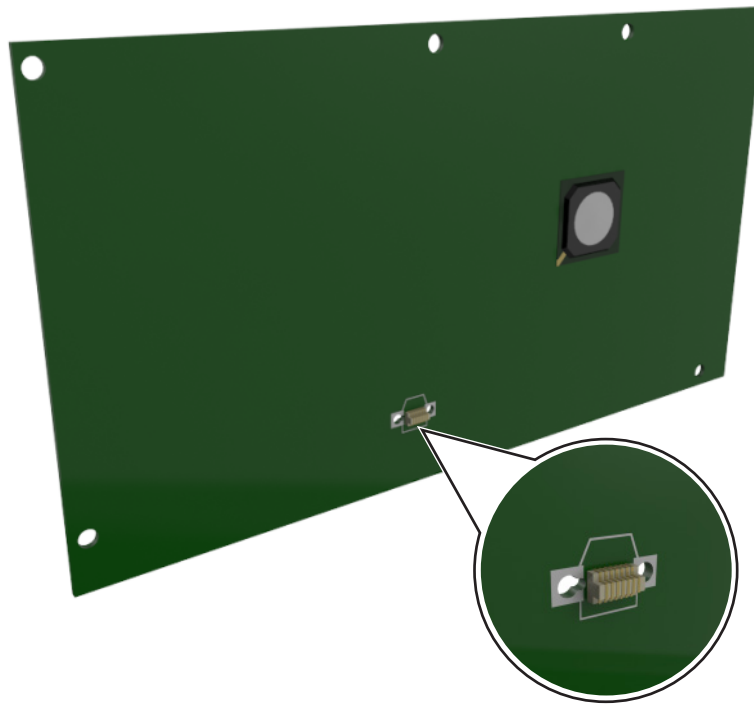

## Installing an optional card

**CAUTION—SHOCK HAZARD:** If you are accessing the controller board or installing optional hardware or memory devices sometime after setting up the printer, then turn the printer off, and unplug the power cord from the electrical outlet before continuing. If you have other devices attached to the printer, then turn them off as well, and unplug any cables going into the printer.

**Warning—Potential Damage:** Controller board electronic components are easily damaged by static electricity. Touch a metal surface on the printer before touching any controller board electronic components or connectors.

- 1 Access the controller board.

For more information, see [“Accessing the controller board” on page 14](#).

- 2 Unpack the optional card.

**Warning—Potential Damage:** Avoid touching the connection points along the edge of the card.

3 Holding the card by its sides, align the plastic pins (1) on the card with the holes (2) on the controller board.

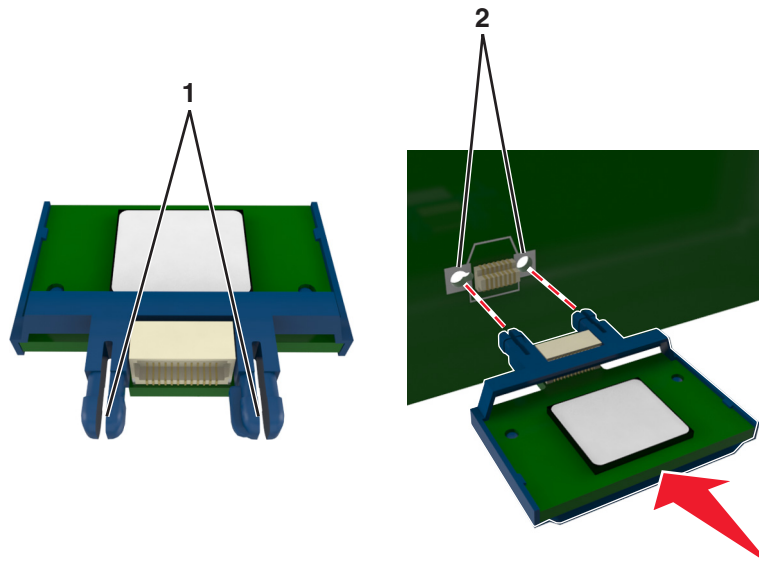

4 Push the card firmly into place as shown in the illustration.

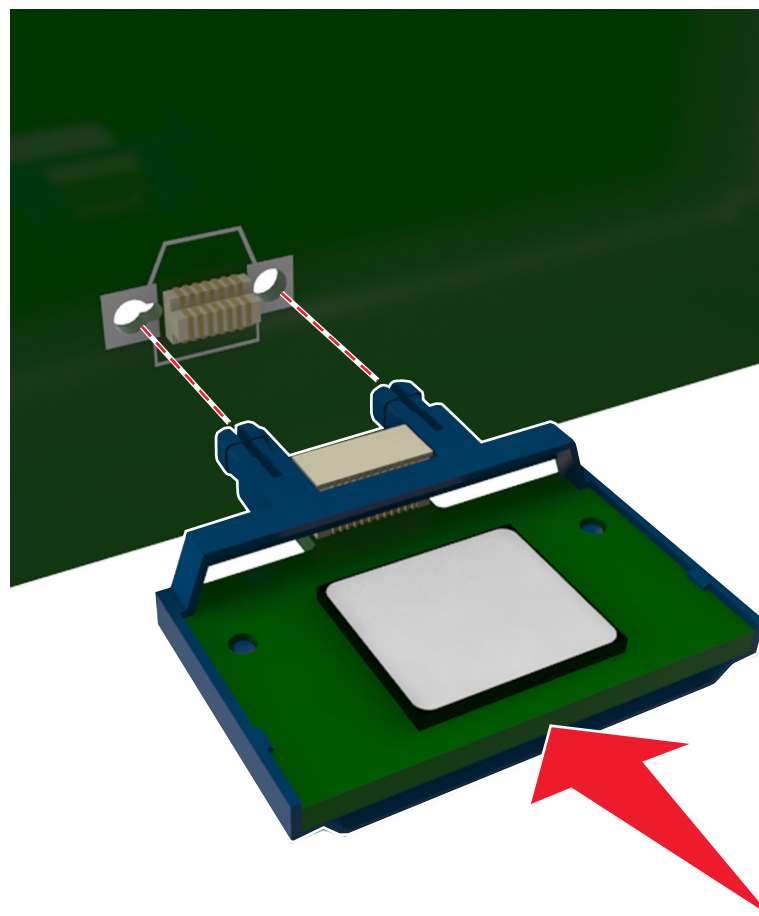



**Warning—Potential Damage:** Improper installation of the card may cause damage to the card and the controller board.

**Note:** The entire length of the connector on the card must touch and be flushed against the controller board.

- 5 Close the controller board access door.

**Note:** When the printer software and any hardware options are installed, it may be necessary to manually add the options in the printer driver to make them available for print jobs. For more information, see [“Adding available options in the print driver” on page 20](#).

## Installing hardware options

### Installing optional trays

**CAUTION—SHOCK HAZARD:** If you are accessing the controller board or installing optional hardware or memory devices sometime after setting up the printer, then turn the printer off, and unplug the power cord from the electrical outlet before continuing. If you have any other devices attached to the printer, then turn them off as well, and unplug any cables going into the printer.

- 1 Turn off the printer using the power switch, and then unplug the power cord from the electrical outlet.



- 2 Unpack the tray, and then remove any packing material.
- 3 Remove the tray from the base.

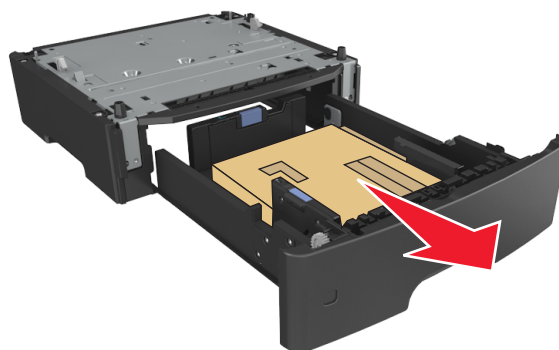

- 4 Remove any packing material from inside the tray.
- 5 Insert the tray into the base.

- 6 Place the tray near the printer.
- 7 Align the printer with the tray, and then slowly lower the printer into place.



- 8 Connect the power cord to the printer, then to a properly grounded electrical outlet, and then turn on the printer.



**Note:** When the printer software and any hardware options are installed, it may be necessary to manually add the options in the printer driver to make them available for print jobs. For more information, see [“Adding available options in the print driver” on page 20](#).

## Attaching cables

Connect the printer to the computer using a USB or parallel cable, or to the network using an Ethernet cable.

Make sure to match the following:

- The USB symbol on the cable with the USB symbol on the printer
- The appropriate parallel cable with the parallel port
- The appropriate Ethernet cable with the Ethernet port

**Warning—Potential Damage:** Do not touch the USB cable, any network adapter, or the printer in the area shown while actively printing. Loss of data or a malfunction can occur.

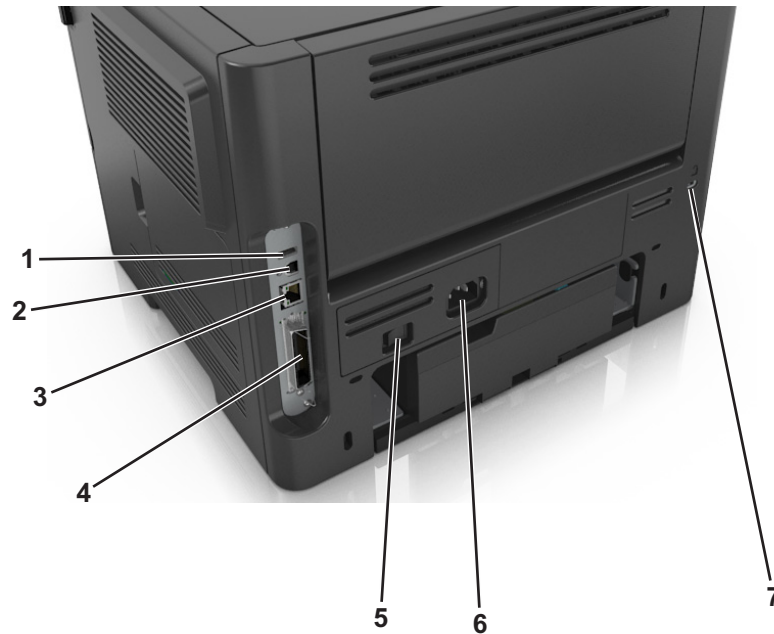

	Use the	To
1	USB port*	Attach an optional wireless network adapter.
2	USB printer port	Connect the printer to a computer.
3	Ethernet port*	Connect the printer to a network.
4	Parallel port*	Connect the printer to a computer.
5	Power switch	Turn on or turn off the printer.
6	Printer power cord socket	Connect the printer to an electrical outlet.
7	Security slot	Attach a lock that will secure the printer in place.

\* These ports are available only in select printer models.

## Setting up the printer software

### Installing the printer

- 1 Obtain a copy of the software installer package.
- 2 Run the installer, and then follow the instructions on the computer screen.
- 3 For Macintosh users, add the printer.

**Note:** Obtain the printer IP address from the TCP/IP section in the Network/Ports menu.

### Installing the Local Printer Settings Utility

- 1 Visit [www.dell.com/support/printers](http://www.dell.com/support/printers), and then download the software.
- 2 Double-click the software installer package.

- 3 Select an installation type, and then click **Install**.
- 4 Click **Install** to start the installation.
- 5 Click **Agree** to accept the license agreement.
- 6 Click **Continue**, and then follow the instructions on the computer screen.

**Notes:**

- Use the Local Printer Settings Utility to change the toner darkness, power saver, and paper size settings for all print jobs. Use the printer software to change these settings for individual print jobs.
- This utility is supported only in select printer models.

## Adding available options in the print driver

### For Windows users

- 1 Open the printers folder, and then select your printer.
- 2 Open the printer properties, and then add or manually install any options.
- 3 Apply the changes.

### For Macintosh users

- 1 From System Preferences in the Apple menu, navigate to your printer, and then select **Options & Supplies > Driver**.
- 2 Add any installed hardware options.
- 3 Apply the changes.

## Networking

**Notes:**

- Purchase a wireless network adapter first before setting up the printer on a wireless network. To install the wireless network adapter, see the instruction sheet that came with the adapter.
- A Service Set Identifier (SSID) is a name assigned to a wireless network. Wired Equivalent Privacy (WEP), Wi-Fi Protected Access (WPA), WPA2, and 802.1X - RADIUS are types of security used on a network.

## Preparing to set up the printer on an Ethernet network

To configure your printer to connect to an Ethernet network, organize the following information before you begin:

**Note:** If your network automatically assigns IP addresses to computers and printers, continue on to installing the printer.

- A valid, unique IP address for the printer to use on the network
- The network gateway

- The network mask
- A nickname for the printer (optional)

**Note:** A printer nickname can make it easier for you to identify your printer on the network. You can choose to use the default printer nickname, or assign a name that is easier for you to remember.

You will need an Ethernet cable to connect the printer to the network and an available port where the printer can physically connect to the network. Use a new network cable when possible to avoid potential problems caused by a damaged cable.

## Preparing to set up the printer on a wireless network

### Notes:

- Make sure your wireless network adapter is installed in your printer and working properly.
- Make sure your access point (wireless router) is turned on and is working properly.

Make sure you have the following information before setting up the printer on a wireless network:

- **SSID**—The SSID is also referred to as the network name.
- **Wireless Mode (or Network Mode)**—The mode is either infrastructure or ad hoc.
- **Channel (for ad hoc networks)**—The channel defaults to automatic for infrastructure networks.

Some ad hoc networks will also require the automatic setting. Check with your system support person if you are not sure which channel to select.

- **Security Method**—There are three basic options for Security Method:

- WEP key

If your network uses more than one WEP key, then enter up to four in the provided spaces. Select the key currently in use on the network by selecting the default WEP transmit key.

*or*

- WPA or WPA2 preshared key or passphrase

WPA includes encryption as an additional layer of security. The choices are AES or TKIP. Encryption must be set for the same type on the router and on the printer, or the printer will not be able to communicate on the network.

- 802.1X–RADIUS

If you are installing the printer on an 802.1X network, then you may need the following:

- Authentication type
- Inner authentication type
- 802.1X user name and password
- Certificates

- No security

If your wireless network does not use any type of security, then you will not have any security information.

**Note:** Using an unsecured wireless network is not recommended.

### Notes:

- If you do not know the SSID of the network that your computer is connected to, then launch the wireless utility of the computer network adapter, and then look for the network name. If you cannot find the SSID or the

security information for your network, then see the documentation that came with the access point, or contact your system support person.

- To find the WPA/WPA2 preshared key/passphrase for the wireless network, see the documentation that came with the access point, see the Web page associated with the access point, or consult your system support person.

## Connecting the printer to a wireless network using Wi-Fi Protected Setup

Before connecting the printer to a wireless network, make sure that:

- The access point (wireless router) is Wi-Fi Protected Setup (WPS) certified or WPS-compatible. For more information, see the documentation that came with your access point.
- A wireless network adapter installed in your printer is attached and working properly. For more information, see the instruction sheet that came with the wireless network adapter.

### Using the Push Button Configuration method

- 1 From the printer control panel, navigate to:

 > Network/Ports >  > Network [x] >  > Network [x] Setup >  > Wireless >  > Wi-Fi Protected Setup >  > Start Push Button Method > 

- 2 Follow the instructions on the printer display.

### Using the Personal Identification Number (PIN) method

- 1 From the printer control panel, navigate to:

 > Network/Ports >  > Network [x] >  > Network [x] Setup >  > Wireless >  > Wi-Fi Protected Setup >  > Start PIN Method > 

- 2 Copy the eight-digit WPS PIN.

- 3 Open a Web browser, and then type the IP address of your access point in the address field.

#### Notes:

- The IP address appears as four sets of numbers separated by periods, such as 123.123.123.123.
- If you are using a proxy server, then temporarily disable it to load the Web page correctly.

- 4 Access the WPS settings. For more information, see the documentation that came with your access point.

- 5 Enter the eight-digit PIN, and then save the setting.

## Connecting the printer to a wireless network using the printer software

### Notes:

- Make sure your printer is turned on.
- Make sure the wireless network adapter installed in your printer is working properly. For information on installing the wireless network adapter, see the instruction sheet that came with the adapter.

### Using the Wireless Setup Utility (Windows only)

- 1 Check if the printer software is already installed.
- 2 Use the search command on the Start menu to locate Printer Home.
- 3 Open Printer Home, and then click **Settings > Wireless Setup Utility**.
- 4 Follow the steps on the computer screen.

### Using the Wireless Setup Assistant (Macintosh only)

The Wireless Setup Assistant lets you:

- Configure the printer to join an existing wireless network.
- Add a printer to an existing ad hoc network.
- Change the wireless settings after installation.
- Install the printer on additional network computers.

### Installing the Wireless Setup Assistant

- 1 Go to the Dell support Web site at [www.dell.com/support/printers](http://www.dell.com/support/printers).
- 2 Download the latest Wireless Setup Assistant application.
- 3 Double-click the downloaded software installer package.
- 4 Follow the instructions on the computer screen.

### Launching the Wireless Setup Assistant

#### Notes:

- Make sure the printer is turned on.
- Make sure a wireless network adapter is installed in your printer and is working properly.

- 1 From the Finder, navigate to:  
**Applications >** select your printer folder
- 2 Double-click **Wireless Setup Assistant**, and then follow the instructions on the computer screen.

**Note:** If you encounter problems while running the application, then click .

## Connecting the printer to a wireless network using the Embedded Web Server

Before you begin, make sure that:

- Your printer is connected temporarily to an Ethernet network.
- A wireless network adapter is installed in your printer and working properly. For more information, see the instruction sheet that came with your wireless network adapter.

**1** Open a Web browser, and then type the printer IP address in the address field.

**Notes:**

- View the printer IP address on the printer control panel. The IP address appears as four sets of numbers separated by periods, such as 123.123.123.123.
- If you are using a proxy server, then temporarily disable it to load the Web page correctly.

**2** Click **Settings > Network/Ports > Wireless**.

**3** Modify the settings to match the settings of your access point (wireless router).

**Note:** Make sure to enter the correct SSID.

**4** Click **Submit**.

**5** Turn off the printer, and then disconnect the Ethernet cable. Then wait for at least five seconds, and then turn the printer back on.

**6** To verify if your printer is connected to the network, print a network setup page. Then in the Network Card [x] section, see if the status is Connected.

## Verifying printer setup

### Printing a menu settings page

Print a menu settings page to review the current menu settings and to verify if the printer options are installed correctly.

**Note:** If you have not changed any menu settings, then the menu settings page lists all the factory default settings. When you select and save other settings from the menus, they replace the factory default settings as *user default settings*. A user default setting remains in effect until you access the menu again, choose another value, and save it.

From the printer control panel, navigate to:





## Printing a network setup page

If the printer is connected to a network, then print a network setup page to verify the network connection. This page also provides important information that aids network printing configuration.

- 1 From the printer control panel, navigate to:



**Note:** If an optional print server is installed, then **Print Network [x] Setup Page** appears.

- 2 Check the first section of the network setup page and confirm that the status is Connected.

If the status is Not Connected, then the LAN drop may not be active, or the network cable may be malfunctioning. Consult your system support person for a solution, and then print another network setup page.

# Loading paper and specialty media

The selection and handling of paper and specialty media can affect how reliably documents print. For more information, see [“Avoiding jams” on page 97](#) and [“Storing paper” on page 43](#).

## Setting the paper size and type

1 From the printer control panel, navigate to:

 > Paper Menu >  > Paper Size/Type > 

2 Select **Tray [x] Size** or **Tray [x] Type**, and then press .

3 Change the paper size or type setting, and then press .

### Notes:

- The paper size setting for the standard 250-sheet tray (Tray 1), optional 550-sheet tray (Tray 2), and the multipurpose feeder must be set manually in the Paper Size menu.
- The factory default paper type for Tray 1 is Plain Paper.
- The factory default paper type for the multipurpose feeder is Custom Type 6.
- The paper type setting must be manually set for all trays.

## Configuring Universal paper settings

The Universal paper size is a user-defined setting that lets you print on paper sizes that are not preset in the printer menus.

### Notes:

- The largest supported Universal size is 216 x 355.6 mm (8.5 x 14 inches).
- The smallest Universal size supported in the multipurpose feeder is 76 x 127 mm (3 x 5 inches). The smallest Universal size supported in the optional tray is 183 x 210 mm (7.2 x 8.3 inches).

From the printer control panel, navigate to:

 > Paper Menu >  > Universal Setup >  > Units of Measure >  > select the unit of measure > 

### Specify the paper height and width

1 From the printer control panel, navigate to:

 > Paper Menu >  > Universal Setup >  > Units of Measure >  > select the unit of measure > 

2 Press the arrow buttons until **Portrait Height** or **Portrait Width** appears, and then press .

- 3 Change the settings, and then press **OK**.

## Using the standard bin and paper stop

The standard bin holds up to 150 sheets of 75-g/m<sup>2</sup> (20-lb) paper. It collects prints facedown. The standard bin includes a paper stop that keeps paper from sliding out the front of the bin as it stacks.

To open the paper stop, pull it so that it flips forward.



**Note:** Close the paper stop when moving the printer to another location.

## Loading trays

**⚠ CAUTION—POTENTIAL INJURY:** To reduce the risk of equipment instability, load each tray separately. Keep all other trays closed until needed.

- 1 Pull out the tray completely.

**Note:** Do not remove trays while a job prints or while **Busy** appears on the printer display. Doing so may cause a jam.



**2** Squeeze and then slide the width guide tab to the correct position for the size of the paper you are loading.

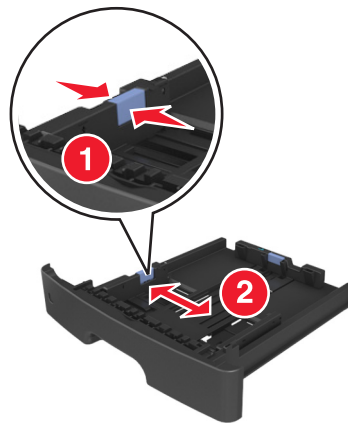

- 3 Squeeze and then slide the length guide tab to the correct position for the size of the paper you are loading.

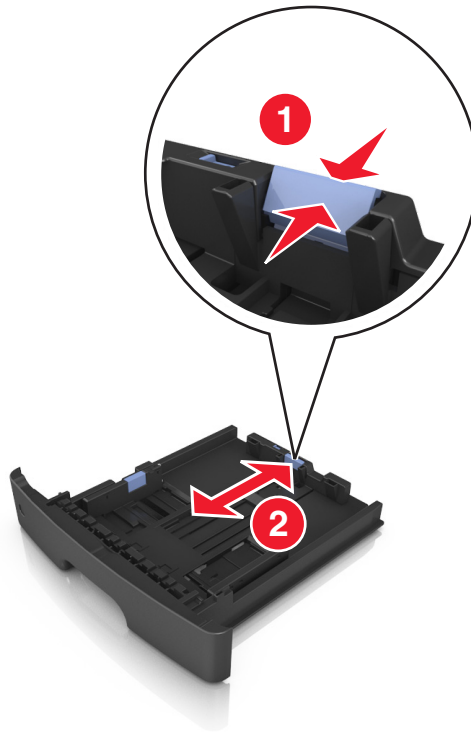
**Notes:**

- For some paper sizes like letter, legal, and A4, squeeze and slide the length guide tab backward to accommodate their length.
- If you are loading A6-size paper in the standard tray, then squeeze and then slide the length guide tab toward the center of the tray to the A6-size position.
- Make sure the width and length guides are aligned with the paper size indicators on the bottom of the tray.

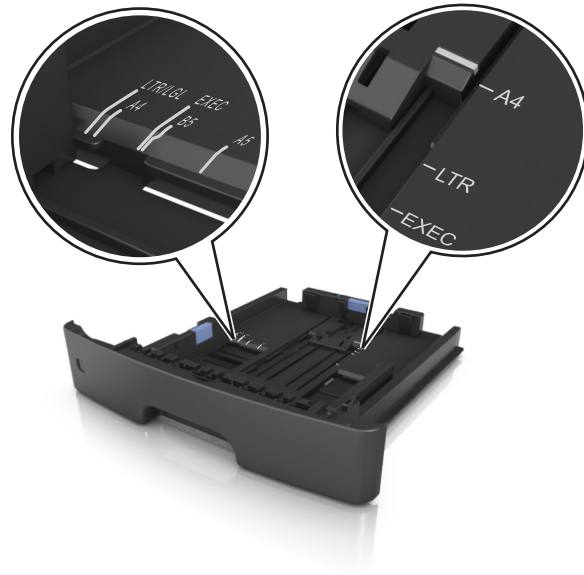

- 4 Flex the sheets back and forth to loosen them, and then fan them. Do not fold or crease the paper. Straighten the edges on a level surface.

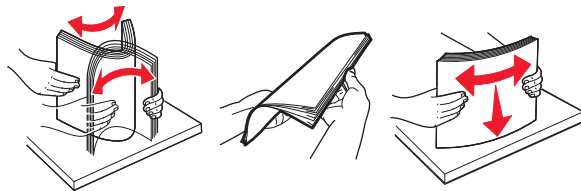

- 5 Load the paper stack.

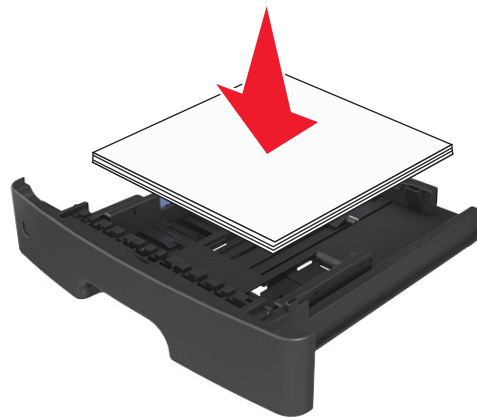

**Notes:**

- Load with the printable side facedown when using recycled or preprinted paper.
- Load prepunched paper with the holes on the top edge toward the front of the tray.
- Load letterhead facedown, with the top edge of the sheet toward the front of the tray. For two-sided printing, load letterhead faceup with the bottom edge of the sheet toward the front of the tray.
- Make sure the paper is below the maximum paper fill indicator located on the side of the width guide.

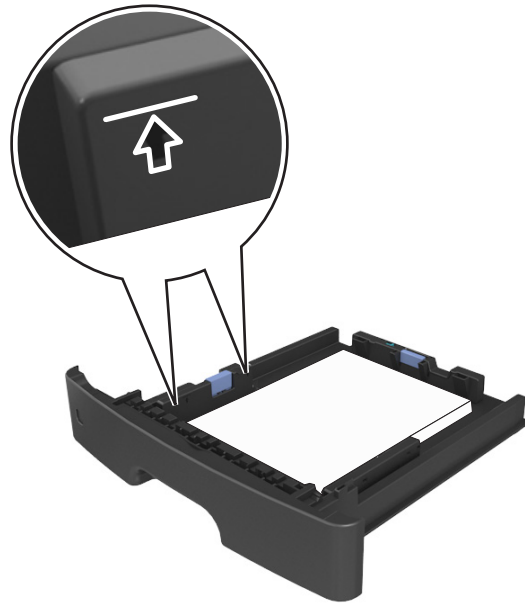

6 Insert the tray.



7 From the printer control panel, set the paper size and paper type in the Paper menu to match the paper loaded in the tray.

**Note:** Set the correct paper size and type to avoid paper jams and print quality problems.

## Loading the multipurpose feeder

Use the multipurpose feeder when printing on different paper sizes and types or specialty media, such as card stock, transparencies, and envelopes. You can also use it for single-page print jobs on letterhead.

- 1 Open the multipurpose feeder.



- a Pull the multipurpose feeder extender.

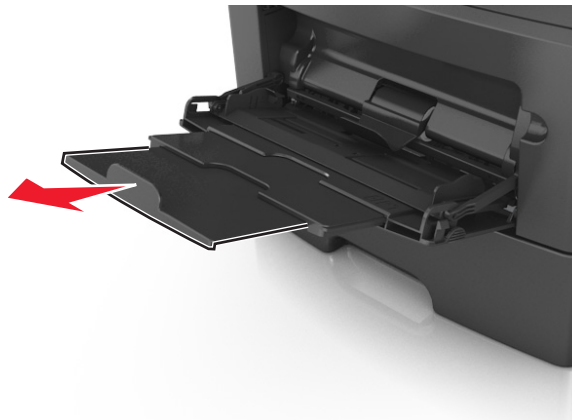

- b Pull the extender gently so that the multipurpose feeder is fully extended and open.





- 2 Squeeze the tab on the left width guide, and then move the guides for the paper you are loading.

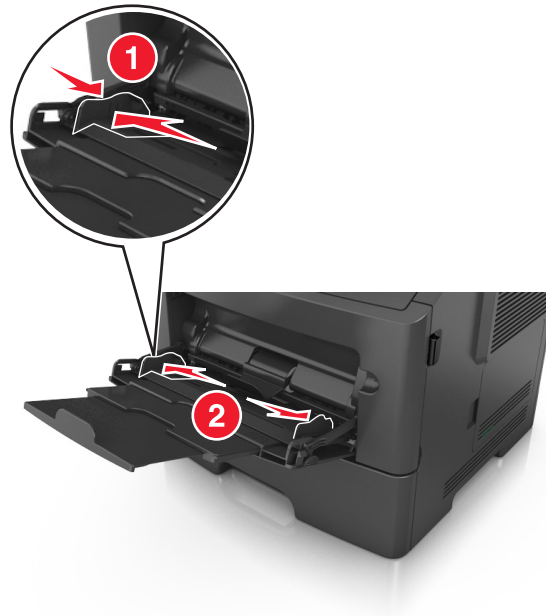

- 3 Prepare the paper or specialty media for loading.

- Flex sheets of paper back and forth to loosen them, and then fan them. Do not fold or crease the paper. Straighten the edges on a level surface.

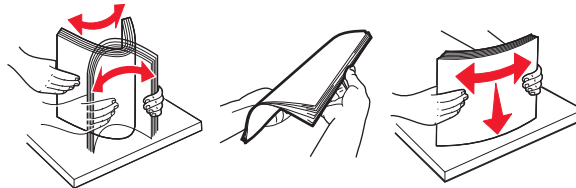

- Hold transparencies by the edges. Flex the stack of transparencies back and forth to loosen them, and then fan them. Straighten the edges on a level surface.

**Note:** Avoid touching the printable side of the transparencies. Be careful not to scratch them.

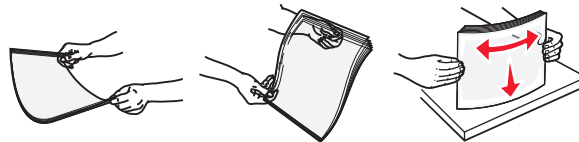

- Flex the stack of envelopes back and forth to loosen them, and then fan them. Straighten the edges on a level surface.



- 4 Load the paper or specialty media.

**Notes:**

- Do not force paper or specialty media into the multipurpose feeder.

- Make sure the paper or specialty media is below the maximum paper fill indicator located on the paper guides. Overfilling may cause paper jams.



- Load paper, transparencies, and card stock with the recommended printable side faceup and the top edge entering the printer first. For more information on loading transparencies, see the packaging that the transparencies came in.

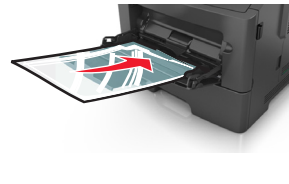

**Note:** When loading A6-size paper, make sure the multipurpose feeder extender rests lightly against the edge of the paper so that the last few sheets of paper remain in place.

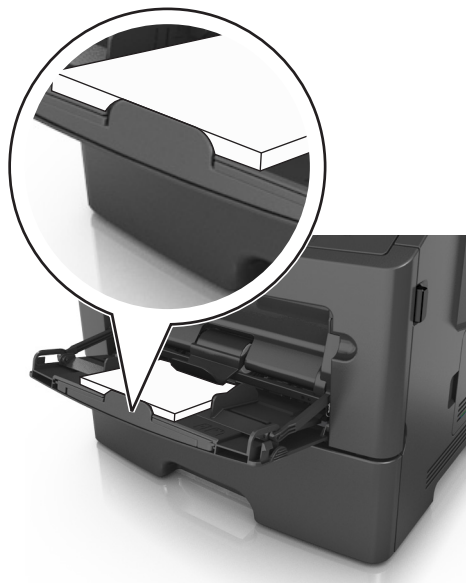

- Load letterhead faceup with the top edge entering the printer first. For two-sided (duplex) printing, load letterhead facedown with the bottom edge entering the printer first.



- Load envelopes with the flap on the left side facedown.



**Warning—Potential Damage:** Never use envelopes with stamps, clasps, snaps, windows, coated linings, or self-stick adhesives. These envelopes may severely damage the printer.

- 5 From the printer control panel, set the paper size and paper type in the Paper menu to match the paper or specialty media loaded in the multipurpose feeder.

## Linking and unlinking trays

When the paper size and paper type for any trays are the same, the printer will link those trays. When one linked tray becomes empty, paper will feed from the next linked tray. We recommend giving all unique paper, such as letterhead and different colored plain papers, a different custom type name so that the trays they are in will not automatically link.

### Linking and unlinking trays

#### Using the Embedded Web Server

- 1 Open a Web browser, and then type the printer IP address in the address field.

**Notes:**

- View the printer IP address in the TCP/IP section in the Network/Ports menu. The IP address appears as four sets of numbers separated by periods, such as 123.123.123.123.

- If you are using a proxy server, then temporarily disable it to load the Web page correctly.

**2** Click **Settings > Paper Menu**.

**3** Change the tray settings to specify the paper size and type for the tray.

- To link trays, make sure the paper size and type for the tray match with that of the other tray.
- To unlink trays, make sure the paper size or type for the tray does *not* match with that of the other tray.

**4** Click **Submit**.

### Using the printer settings on the computer

Depending on your operating system, access the Paper menu using the Local Printer Settings Utility or Printer Settings.

**Note:** You can also specify the paper size and type for the tray using the printer control panel. For more information, see [“Setting the paper size and type” on page 26](#).

**Warning—Potential Damage:** Paper loaded in the tray should match the paper type name assigned in the printer. The temperature of the fuser varies according to the specified paper type. Printing issues may occur if settings are not properly configured.

## Configuring a custom paper type

### Using the Embedded Web Server

**1** Open a Web browser, and then type the printer IP address in the address field.

**Notes:**

- Print a network setup page or menu settings page, and then locate the IP address in TCP/IP section. The IP address appears as four sets of numbers separated by periods, such as 123.123.123.123.
- If you are using a proxy server, then temporarily disable it to load the Web page correctly.

**2** Click **Settings > Paper Menu > Custom Types**.

**3** Select a custom paper type name, and then select a custom paper type.

**Note:** Plain Paper is the factory default paper type for all user-defined custom names.

**4** Click **Submit**.

### Using the printer settings on the computer

Depending on your operating system, access the Custom menu using the Local Printer Settings Utility or Printer Settings.

## Assigning a custom paper type

### Using the Embedded Web Server

**1** Open a Web browser, and then type the printer IP address in the address field.

**Notes:**

- Print a network setup page or menu settings page, and then locate the IP address in the TCP/IP section. The IP address appears as four sets of numbers separated by periods, such as 123.123.123.123.

- If you are using a proxy server, then temporarily disable it to load the Web page correctly.

**2** Click **Settings > Paper Menu**.

**3** From the Tray Configuration section, select a paper source, and then select a custom paper type under the paper type column.

**4** Click **Submit**.

### **Using the printer settings on the computer**

Depending on your operating system, access the Paper menu using the Local Printer Settings Utility or Printer Settings.

# Paper and specialty media guide

## Paper guidelines

Selecting the correct paper or specialty media reduces printing problems. For the best print quality, try a sample of the paper or specialty media before buying large quantities.

## Paper characteristics

The following paper characteristics affect print quality and reliability. Consider these characteristics when evaluating new paper stock.

### Weight

The printer trays can automatically feed paper weights up to 120-g/m<sup>2</sup> (32-lb) bond grain long paper. The multipurpose feeder can automatically feed paper weights up to 163-g/m<sup>2</sup> (43-lb) bond grain long paper. Paper lighter than 60 g/m<sup>2</sup> (16 lb) might not be stiff enough to feed properly, causing jams. For best performance, use 75-g/m<sup>2</sup> (20-lb) bond grain long paper. For paper smaller than 182 x 257 mm (7.2 x 10.1 inches), we recommended to use 90 g/m<sup>2</sup> (24 lb) or heavier paper.

**Note:** Two-sided printing is supported only for 60–90-g/m<sup>2</sup> (16–24-lb) bond paper.

### Curl

Curl is the tendency for paper to curl at its edges. Excessive curl can cause paper feeding problems. Curl can occur after the paper passes through the printer, where it is exposed to high temperatures. Storing paper unwrapped in hot, humid, cold, or dry conditions, even in the trays, can contribute to paper curling prior to printing and can cause feeding problems.

### Smoothness

Paper smoothness directly affects print quality. If paper is too rough, then toner cannot fuse to it properly. If paper is too smooth, then it can cause paper feeding or print quality issues. Always use paper between 100 and 300 Sheffield points; however, smoothness between 150 and 250 Sheffield points produces the best print quality.

### Moisture content

The amount of moisture in paper affects both print quality and the ability of the printer to feed the paper correctly. Leave paper in its original wrapper until it is time to use it. This limits the exposure of paper to moisture changes that can degrade its performance.

Store paper in its original wrapper in the same environment as the printer for 24 to 48 hours before printing. Extend the time to several days if the storage or transportation environment is very different from the printer environment. Thick paper may also require a longer conditioning period.

### Grain direction

Grain refers to the alignment of the paper fibers in a sheet of paper. Grain is either *grain long*, running the length of the paper, or *grain short*, running the width of the paper.

For 60–90-g/m<sup>2</sup> (16–24-lb) bond paper, grain long paper is recommended.

## Fiber content

Most high-quality xerographic paper is made from 100% chemically treated pulped wood. This content provides the paper with a high degree of stability resulting in fewer paper feeding problems and better print quality. Paper containing fibers such as cotton can negatively affect paper handling.

## Unacceptable paper

The following paper types are not recommended for use with the printer:

- Chemically treated papers used to make copies without carbon paper, also known as carbonless papers, carbonless copy paper (CCP), or no carbon required (NCR) paper
- Preprinted papers with chemicals that may contaminate the printer
- Preprinted papers that can be affected by the temperature in the printer fuser
- Preprinted papers that require a registration (the precise print location on the page) less than ±2.5 mm (±0.10 inch), such as optical character recognition (OCR) forms

In some cases, registration can be adjusted with a software application to successfully print on these forms:

- Coated papers (erasable bond), synthetic papers, thermal papers
- Rough-edged, rough or heavily textured surface papers, or curled papers
- Recycled papers that fail EN12281:2002 (European)
- Paper weighing less than 60 g/m<sup>2</sup> (16 lb)
- Multiple-part forms or documents

## Selecting paper

Using the appropriate paper prevents jams and helps ensure trouble-free printing.

To help avoid paper jams and poor print quality:

- *Always* use new, undamaged paper.
- Before loading paper, know the recommended printable side of the paper. This information is usually indicated on the paper package.
- *Do not* use paper that has been cut or trimmed by hand.
- *Do not* mix paper sizes, types, or weights in the same tray; mixing results in jams.
- *Do not* use coated papers unless they are specifically designed for electrophotographic printing.

## Selecting preprinted forms and letterhead

Use these guidelines when selecting preprinted forms and letterhead:

- Use grain long for 60 to 90 g/m<sup>2</sup> (16 to 24 lb) weight paper.
- Use only forms and letterhead printed using an offset lithographic or engraved printing process.
- Avoid papers with rough or heavily textured surfaces.

Use papers printed with heat-resistant inks designed for use in xerographic copiers. The ink must be able to withstand temperatures up to 230°C (446°F) without melting or releasing hazardous emissions. Use inks that are not affected by the resin in toner. Inks that are oxidation-set or oil-based generally meet these requirements; latex inks might not. When in doubt, contact the paper supplier.

Preprinted papers such as letterhead must be able to withstand temperatures up to 230°C (446°F) without melting or releasing hazardous emissions.

## Using recycled paper and other office papers

Recycled office paper produced specifically for use in laser (electrophotographic) printers may be used in your printer. However, no blanket statement can be made that all recycled paper will feed well.

Generally, the following property guidelines apply to recycled paper.

- Amount of post-consumer waste (We test up to 100% post-consumer waste content.)
- Temperature and humidity conditions (Testing chambers simulate climates from all over the world.)
- Moisture content (Business papers should have low moisture: 4–5%.)
- Bending resistance and proper stiffness means optimum feeding through the printer.
- Thickness (impacts how much can be loaded into a tray)
- Surface roughness (measured in Sheffield units, impacts print clarity and how well toner fuses to the paper)
- Surface friction (determines how easily sheets can be separated)
- Grain and formation (impacts curling, which also influences the mechanics of how the paper behaves as it moves through the printer)
- Brightness and texture (look and feel)

Recycled papers are better than ever; however, the amount of recycled content in a paper affects the degree of control over foreign matter. And while recycled papers are one good path to printing in an environmentally responsible manner, they are not perfect. The energy required to de-ink and deal with additives such as colorants and “glue” often generates more carbon emissions than does normal paper production. However, using recycled papers enables better resource management overall.

## Unacceptable paper examples

Test results indicate that the following paper types are at risk for use with laser printers:

- Chemically treated papers used to make copies without carbon paper, also known as *carbonless papers*
- Preprinted papers with chemicals that may contaminate the printer
- Preprinted papers that can be affected by the temperature in the printer fuser
- Preprinted papers that require a registration (the precise location on the page) greater than  $\pm 2.3$  mm ( $\pm 0.9$  in.), such as optical character recognition (OCR) forms. In some cases, registration can be adjusted with a software application to successfully print on these forms.)
- Coated papers (erasable bond), synthetic papers, thermal papers
- Rough-edged, rough or heavily textured surface papers or curled papers
- Recycled papers that fail EN12281:2002 (European testing)
- Paper weighing less than 60 g/m<sup>2</sup> (16 lb)
- Multiple part forms or documents



## Using specialty media

### Tips on using card stock

Card stock is heavy, single-ply specialty media. Many of its variable characteristics, such as moisture content, thickness, and texture, can significantly impact print quality. Print samples on the card stock being considered for use before buying large quantities.

When printing on card stock:

- Make sure the Paper Type is Card Stock.
- Select the appropriate Paper Texture setting.
- Be aware that preprinting, perforation, and creasing may significantly affect the print quality and cause jams or other paper handling problems.
- Check with the manufacturer or vendor to ensure that the card stock can withstand temperatures up to 240°C (464°F) without releasing hazardous emissions.
- Do not use preprinted card stock manufactured with chemicals that may contaminate the printer. Preprinting introduces semi-liquid and volatile components into the printer.
- Use grain short card stock when possible.

### Tips on using envelopes

Print samples on the envelopes being considered for use before buying large quantities.

- Use envelopes designed specifically for laser printers. Check with the manufacturer or vendor to ensure that the envelopes can withstand temperatures up to 230°C (446°F) without sealing, wrinkling, curling excessively, or releasing hazardous emissions.
- For best performance, use envelopes made from 90-g/m<sup>2</sup> (24-lb bond) paper or 25% cotton. All-cotton envelopes must not exceed 70-g/m<sup>2</sup> (20-lb bond) weight.
- Use only new envelopes from undamaged packages.
- To optimize performance and minimize jams, do not use envelopes that:
  - Have excessive curl or twist
  - Are stuck together or damaged in any way
  - Have windows, holes, perforations, cutouts, or embossing
  - Have metal clasps, string ties, or folding bars
  - Have an interlocking design
  - Have postage stamps attached
  - Have any exposed adhesive when the flap is in the sealed or closed position
  - Have bent corners
  - Have rough, cockle, or laid finishes
- Adjust the width guides to fit the width of the envelopes.

**Note:** A combination of high humidity (over 60%) and high printing temperature may wrinkle or seal envelopes.

## Tips on using labels

Print samples on the labels being considered for use before buying large quantities.

**Note:** Use only paper label sheets. Vinyl, pharmacy, and two-sided labels are not supported.

When printing on labels:

- Use labels designed specifically for laser printers. Check with the manufacturer or vendor to verify that:
  - The labels can withstand temperatures up to 240°C (464°F) without sealing, excessive curling, wrinkling, or releasing hazardous emissions.
  - Label adhesives, face sheet (printable stock), and topcoats can withstand up to 172-kPa (25-psi) pressure without delaminating, oozing around the edges, or releasing hazardous fumes.
- Do not use labels with slick backing material.
- Use full label sheets. Partial sheets may cause labels to peel off during printing, resulting in a jam. Partial sheets also contaminate the printer and the cartridge with adhesive, and could void the printer and toner cartridge warranties.
- Do not use labels with exposed adhesive.
- Do not print within 1 mm (0.04 inch) of the edge of the label, of the perforations, or between die-cuts of the label.
- Make sure the adhesive backing does not reach to the edge of the sheet. Zone coating of the adhesive should be at least 1 mm (0.04 inch) away from edges. Adhesive material contaminates the printer and could void the warranty.
- If zone coating of the adhesive is not possible, then remove a 2-mm (0.08-inch) strip on the leading and driver edge, and then use a non-oozing adhesive.
- Portrait orientation is recommended, especially when printing bar codes.

## Tips on using letterhead

- Use letterhead designed specifically for laser printers.
- Print samples on the letterhead being considered for use before buying large quantities.
- Before loading letterhead, flex, fan, and straighten the stack to prevent sheets from sticking together.
- Page orientation is important when printing on letterhead. For information on how to load letterhead, see:
  - [“Loading trays” on page 27](#)
  - [“Loading the multipurpose feeder” on page 32](#)

## Tips on using transparencies

- Print a test page on the transparencies being considered for use before buying large quantities.
- Feed transparencies from the standard tray, or the multipurpose feeder.
- Use transparencies designed specifically for laser printers. Transparencies must be able to withstand temperatures up to 185°C (365°F) without melting, discoloring, offsetting, or releasing hazardous emissions.

**Note:** If the transparency weight is set to Heavy and the transparency texture is set to Rough in the Paper menu, then transparencies can be printed at a temperature up to 195°C (383°F).
- Avoid getting fingerprints on the transparencies to prevent print quality problems.
- Before loading transparencies, flex, fan, and straighten the stack to prevent sheets from sticking together.

## Storing paper

Use these paper storage guidelines to help avoid jams and uneven print quality:

- For best results, store paper where the temperature is 21°C (70°F) and the relative humidity is 40 percent. Most label manufacturers recommend printing in a temperature range of 18–24°C (65–75°F) with relative humidity between 40 and 60 percent.
- Store paper in cartons, on a pallet or shelf, rather than on the floor.
- Store individual packages on a flat surface.
- Do not store anything on top of individual paper packages.
- Take paper out of the carton or wrapper only when you are ready to load it in the printer. The carton and wrapper help keep the paper clean, dry, and flat.

## Supported paper sizes, types, and weights

For information on card stock and labels, see the *Card Stock & Label Guide*.

### Supported paper sizes

Paper size	Standard tray	Optional 250- or 550-sheet tray	Multipurpose feeder	Duplex mode
<b>A4</b> 210 x 297 mm (8.3 x 11.7 in.)	✓	✓	✓	✓
<b>A5</b> 148 x 210 mm (5.8 x 8.3 in.)	✓	✓	✓	x
<b>A6</b> 105 x 148 mm (4.1 x 5.8 in.)	✓	x	✓	x
<b>JIS B5</b> 182 x 257 mm (7.2 x 10.1 in.)	✓	✓	✓	x
<b>Letter</b> 216 x 279 mm (8.5 x 11 in.)	✓	✓	✓	✓
<b>Legal</b> 216 x 356 mm (8.5 x 14 in.)	✓	✓	✓	✓
<b>Executive</b> 184 x 267 mm (7.3 x 10.5 in.)	✓	✓	✓	x
<b>Oficio (Mexico)</b> 216 x 340 mm (8.5 x 13.4 in.)	✓	✓	✓	✓

<sup>1</sup> This size setting formats the page for 216 x 356 mm (8.5 x 14 in.) unless the size is specified by the software application.

<sup>2</sup> Universal is supported in the standard tray only if the paper size is at least 105 x 148 mm (4.1 x 5.8 in.). Universal is supported in the optional 250- or 550-sheet tray only if the paper size is at least 148 x 210 mm (5.8 x 8.3 in.). Universal is supported in duplex mode only if the width is at least 210 mm (8.3 in.) and the length is at least 279 mm (11 in.). The smallest supported Universal size is supported only in the multipurpose feeder.

Paper size	Standard tray	Optional 250- or 550-sheet tray	Multipurpose feeder	Duplex mode
<b>Folio</b> 216 x 330 mm (8.5 x 13 in.)	✓	✓	✓	✓
<b>Statement</b> 140 x 216 mm (5.5 x 8.5 in.)	✓	✓	✓	X
<b>Universal</b> <sup>1,2</sup> 76.2 x 127 mm (3 x 5 in.) up to 216 x 356 mm (8.5 x 14 in.)	✓	✓	✓	✓
<b>7 3/4 Envelope (Monarch)</b> 98 x 191 mm (3.9 x 7.5 in.)	X	X	✓	X
<b>9 Envelope</b> 98 x 225 mm (3.9 x 8.9 in.)	X	X	✓	X
<b>10 Envelope</b> 105 x 241 mm (4.1 x 9.5 in.)	X	X	✓	X
<b>DL Envelope</b> 110 x 220 mm (4.3 x 8.7 in.)	X	X	✓	X
<b>C5 Envelope</b> 162 x 229 mm (6.4 x 9 in.)	X	X	✓	X
<b>B5 Envelope</b> 176 x 250 mm (6.9 x 9.8 in.)	X	X	✓	X
<b>Other Envelope</b> 229 x 356 mm (9 x 14 in.)	X	X	✓	X
<p><sup>1</sup> This size setting formats the page for 216 x 356 mm (8.5 x 14 in.) unless the size is specified by the software application.</p> <p><sup>2</sup> Universal is supported in the standard tray only if the paper size is at least 105 x 148 mm (4.1 x 5.8 in.). Universal is supported in the optional 250- or 550-sheet tray only if the paper size is at least 148 x 210 mm (5.8 x 8.3 in.). Universal is supported in duplex mode only if the width is at least 210 mm (8.3 in.) and the length is at least 279 mm (11 in.). The smallest supported Universal size is supported only in the multipurpose feeder.</p>				

## Supported paper types and weights

The standard tray supports 60–90-g/m<sup>2</sup> (16–24-lb) paper weights. The optional tray supports 60–120-g/m<sup>2</sup> (16–32-lb) paper weights. The multipurpose feeder supports 60–163-g/m<sup>2</sup> (16–43-lb) paper weights.

Paper type	250- or 550-sheet tray	Multipurpose feeder	Duplex mode
<b>Plain paper</b>	✓	✓	✓
<b>Card stock</b>	X	✓	X
<b>Transparencies</b>	✓	✓	X
<b>Recycled</b>	✓	✓	✓

Paper type	250- or 550-sheet tray	Multipurpose feeder	Duplex mode
<b>Glossy paper</b>	X	X	X
<b>Paper labels<sup>1</sup></b>	✓	✓	X
<b>Vinyl labels</b>	X	X	X
<b>Bond<sup>2</sup></b>	✓	✓	✓
<b>Envelope</b>	X	✓	X
<b>Rough envelope</b>	X	✓	X
<b>Letterhead</b>	✓	✓	✓
<b>Preprinted</b>	✓	✓	✓
<b>Colored Paper</b>	✓	✓	✓
<b>Light Paper</b>	✓	✓	✓
<b>Heavy Paper<sup>2</sup></b>	✓	✓	✓
<b>Rough/Cotton</b>	✓	✓	X

<sup>1</sup> One-sided paper labels designed for laser printers are supported for occasional use. It is recommended to print 20 or fewer pages of paper labels per month. Vinyl, pharmacy, and two-sided labels are not supported.

<sup>2</sup> Bond and Heavy Paper are supported in duplex mode up to 90-g/m<sup>2</sup> (24-lb) paper weight.

# Printing

## Printing a document

### Printing a document

- 1 From the Paper menu on the printer control panel, set the paper type and size to match the paper loaded.
- 2 Send the print job:

#### For Windows users

- a With a document open, click **File > Print**.
- b Click **Properties, Preferences, Options, or Setup**.
- c Adjust the settings, if necessary.
- d Click **OK > Print**.

#### For Macintosh users

- a Customize the settings in the Page Setup dialog:
  - 1 With a document open, choose **File > Page Setup**.
  - 2 Choose a paper size or create a custom size to match the paper loaded.
  - 3 Click **OK**.
- b Customize the settings in the Print dialog:
  - 1 With a document open, choose **File > Print**.  
If necessary, click the disclosure triangle to see more options.
  - 2 From the Print dialog and pop-up menus, adjust the settings if necessary.  
**Note:** To print on a specific paper type, adjust the paper type setting to match the paper loaded, or select the appropriate tray or feeder.
  - 3 Click **Print**.

## Adjusting toner darkness

### Using the Embedded Web Server

- 1 Open a Web browser, and then type the printer IP address in the address field.

#### Notes:

- View the printer IP address in the TCP/IP section in the Network/Ports menu. The IP address appears as four sets of numbers separated by periods, such as 123.123.123.123.
- If you are using a proxy server, then temporarily disable it to load the Web page correctly.

- 2 Click **Settings > Print Settings > Quality Menu > Toner Darkness**.
- 3 Adjust the toner darkness setting.
- 4 Click **Submit**.

## Using the printer settings on the computer

Depending on your operating system, adjust the toner darkness settings using the Local Printer Settings Utility or Printer Settings.

## Using the printer control panel

- 1 From the printer control panel, navigate to:

 > Settings >  > Print Settings >  > Quality Menu >  > Toner Darkness > 

- 2 Adjust the toner darkness.

- 3 Press .

# Printing from a mobile device

## Printing from a mobile device using AirPrint

AirPrint™ is a mobile printing application that allows you to print directly from your iPad® (all models), iPhone® (3GS or later), or iPod touch® (3rd generation or later) to your AirPrint-enabled printer. AirPrint-enabled printers work with these mobile devices that run the latest version of iOS.

**Note:** Make sure the printer and the mobile device share the same wireless network. For information on configuring the wireless settings of your mobile device, see the documentation that came with the device.

- 1 From the home screen of your mobile device, launch the application.

**Note:** You can print any content from these Apple applications: iBook, Mail, Photos, Safari, and some select App Store applications.

- 2 Select the item to print, and then tap .
- 3 Tap **Print**, and then choose your printer.
- 4 Set the print options you want, and then tap **Print**.

## Printing from a mobile device using Dell Mobile Print

You can print directly from an Android mobile device (OS 2.1 or later) to your printer using Dell Mobile Print.

### Notes:

- Make sure the printer and the mobile device share the same wireless network.
- For information on configuring the wireless settings, see the documentation that came with your mobile device.

- 1 From Google Play, download the Dell Mobile Print application.



- 2 From the home screen of your mobile device, tap .

### 3 Select the item to print.

You can choose from the list of supported applications (such as Calendar, Contacts, Gallery, Google Docs, GMail, Internet, Messaging, Word Documents, Excel Documents, PowerPoint Documents, and PDF Documents).

### 4 From the print preview dialog, set the print and printer options if necessary.

**Note:** If your printer does not appear in the list, then check the network settings of both your printer and your mobile device to make sure that both share the same wireless network.

### 5 Tap **Print**.

## Printing information pages

For more information on printing information pages, see [“Printing a menu settings page” on page 24](#) and [“Printing a network setup page” on page 25](#).

### Printing a font sample list

From the printer control panel, navigate to either of the following:



 > Reports >  > Print Fonts >  > PCL Fonts > 

or

 > Reports >  > Print Fonts >  > PostScript Fonts > 

## Canceling a print job

### Canceling a print job from the printer control panel

From the printer control panel, press  > .

### Canceling a print job from the computer

#### For Windows users

- 1 Open the printers folder, and then select your printer.
- 2 From the print queue, select the print job you want to cancel, and then delete it.

#### For Macintosh users

- 1 From System Preferences in the Apple menu, navigate to your printer.
- 2 From the print queue, select the print job you want to cancel, and then delete it.



# Understanding the printer menus

## Menus list

### Paper Menu

- Default Source
- Paper Size/Type
- Configure MP
- Substitute Size
- Paper Texture
- Paper Weight
- Paper Loading
- Custom Types
- Universal Setup

### Reports

- Menu Settings Page
- Device Statistics
- Network Setup Page<sup>1</sup>
- Profiles List
- Print Fonts
- Print Directory
- Asset Report

### Network/Ports<sup>3</sup>

- Active NIC
- Standard Network<sup>2</sup>
- Reports
- Network card
- TCP/IP
- IPv6
- Wireless
- AppleTalk
- Standard USB
- SMTP Setup

### Security

- Security Audit Log
- Set Date and Time

### Settings

- General Settings
- Print Settings

<sup>1</sup> Depending on the printer setup, this menu item appears as Network Setup Page or Network [x] Setup Page.

<sup>2</sup> Depending on the printer setup, this menu item appears as Standard Network or Network [x].

<sup>3</sup> The menu items in this menu appear only in network printers or printers connected to print servers.

## Paper menu

### Default Source menu

Use	To
<p><b>Default Source</b></p> <ul style="list-style-type: none"> <li>Tray [x]</li> <li>MP Feeder</li> <li>Manual Paper</li> <li>Manual Envelope</li> </ul>	<p>Set a default paper source for all print jobs.</p> <p><b>Notes:</b></p> <ul style="list-style-type: none"> <li>• Tray 1 (standard tray) is the factory default setting.</li> <li>• From the Paper menu, set Configure MP to "Cassette" for MP Feeder to appear as a menu setting.</li> <li>• If two trays contain paper of the same size and type, and the trays have the same settings, then the trays are automatically linked. When one tray is empty, the print job continues using the linked tray.</li> </ul>

## Paper Size/Type menu

Use	To
<p><b>Tray [x] Size</b></p> <ul style="list-style-type: none"> <li>A4</li> <li>A5</li> <li>A6</li> <li>JIS-B5</li> <li>Letter</li> <li>Legal</li> <li>Executive</li> <li>Oficio (Mexico)</li> <li>Folio</li> <li>Statement</li> <li>Universal</li> </ul>	<p>Specify the paper size loaded in each tray.</p> <p><b>Notes:</b></p> <ul style="list-style-type: none"> <li>• Letter is the U.S. factory default setting. A4 is the international factory default setting.</li> <li>• If two trays contain paper of the same size and type, and the trays have the same settings, then the trays are automatically linked. When one tray is empty, the print job continues using the linked tray.</li> <li>• The A6 paper size is supported only in Tray 1 and the multipurpose feeder.</li> </ul>
<p><b>Tray [x] Type</b></p> <ul style="list-style-type: none"> <li>Plain Paper</li> <li>Transparency</li> <li>Recycled</li> <li>Labels</li> <li>Bond</li> <li>Letterhead</li> <li>Preprinted</li> <li>Colored Paper</li> <li>Light Paper</li> <li>Heavy Paper</li> <li>Rough/Cotton</li> <li>Custom Type [x]</li> </ul>	<p>Specify the type of paper loaded in each tray.</p> <p><b>Notes:</b></p> <ul style="list-style-type: none"> <li>• Plain Paper is the factory default setting for Tray 1. Custom Type [x] is the factory default setting for all other trays.</li> <li>• If available, a user-defined name will appear instead of Custom Type [x].</li> <li>• Use this menu to configure automatic tray linking.</li> </ul>
<p><b>Note:</b> Only installed trays and feeders are listed in this menu.</p>	

Use	To
<p><b>MP Feeder Size</b></p> <ul style="list-style-type: none"> <li>A4</li> <li>A5</li> <li>A6</li> <li>JIS B5</li> <li>Letter</li> <li>Legal</li> <li>Executive</li> <li>Oficio (Mexico)</li> <li>Folio</li> <li>Statement</li> <li>Universal</li> <li>7 3/4 Envelope</li> <li>9 Envelope</li> <li>10 Envelope</li> <li>DL Envelope</li> <li>C5 Envelope</li> <li>B5 Envelope</li> <li>Other Envelope</li> </ul>	<p>Specify the paper size loaded in the multipurpose feeder.</p> <p><b>Notes:</b></p> <ul style="list-style-type: none"> <li>• Letter is the U.S. factory default setting. A4 is the international factory default setting.</li> <li>• From the Paper menu, set Configure MP to “Cassette” for MP Feeder Size to appear as a menu.</li> <li>• The multipurpose feeder does not automatically detect paper size. Make sure to set the paper size value.</li> </ul>
<p><b>MP Feeder Type</b></p> <ul style="list-style-type: none"> <li>Plain Paper</li> <li>Card Stock</li> <li>Transparency</li> <li>Recycled</li> <li>Labels</li> <li>Bond</li> <li>Envelope</li> <li>Rough Envelope</li> <li>Letterhead</li> <li>Preprinted</li> <li>Colored Paper</li> <li>Light Paper</li> <li>Heavy Paper</li> <li>Rough/Cotton</li> <li>Custom Type [x]</li> </ul>	<p>Specify the type of paper loaded in the multipurpose feeder.</p> <p><b>Notes:</b></p> <ul style="list-style-type: none"> <li>• Custom Type [x] is the factory default setting.</li> <li>• From the Paper menu, set Configure MP to “Cassette” for MP Feeder Type to appear as a menu.</li> </ul>
<p><b>Note:</b> Only installed trays and feeders are listed in this menu.</p>	

Use	To
<p><b>Manual Paper Size</b></p> <ul style="list-style-type: none"> <li>A4</li> <li>A5</li> <li>A6</li> <li>JIS B5</li> <li>Letter</li> <li>Legal</li> <li>Executive</li> <li>Oficio (Mexico)</li> <li>Folio</li> <li>Statement</li> <li>Universal</li> </ul>	<p>Specify the paper size being manually loaded.</p> <p><b>Note:</b> Letter is the U.S. factory default setting. A4 is the international factory default setting.</p>
<p><b>Manual Paper Type</b></p> <ul style="list-style-type: none"> <li>Plain Paper</li> <li>Card Stock</li> <li>Transparency</li> <li>Recycled</li> <li>Labels</li> <li>Bond</li> <li>Letterhead</li> <li>Preprinted</li> <li>Colored Paper</li> <li>Light Paper</li> <li>Heavy Paper</li> <li>Rough/Cotton</li> <li>Custom Type [x]</li> </ul>	<p>Specify the paper type being manually loaded.</p> <p><b>Notes:</b></p> <ul style="list-style-type: none"> <li>• Plain Paper is the factory default setting.</li> <li>• From the Paper menu, set Configure MP to “Manual” for Manual Paper Type to appear as a menu.</li> </ul>
<p><b>Manual Envelope Size</b></p> <ul style="list-style-type: none"> <li>7 3/4 Envelope</li> <li>9 Envelope</li> <li>10 Envelope</li> <li>DL Envelope</li> <li>C5 Envelope</li> <li>B5 Envelope</li> <li>Other Envelope</li> </ul>	<p>Specify the envelope size being manually loaded.</p> <p><b>Note:</b> 10 Envelope is the U.S. factory default setting. DL Envelope is the international factory default setting.</p>
<p><b>Manual Envelope Type</b></p> <ul style="list-style-type: none"> <li>Envelope</li> <li>Rough Envelope</li> <li>Custom Type [x]</li> </ul>	<p>Specify the envelope type being manually loaded.</p> <p><b>Note:</b> Envelope is the factory default setting.</p>
<p><b>Note:</b> Only installed trays and feeders are listed in this menu.</p>	

## Configure MP menu

Use	To
<b>Configure MP</b> Cassette Manual First	Determine when the printer selects paper from the multipurpose feeder.  <b>Notes:</b> <ul style="list-style-type: none"> <li>• Cassette is the factory default setting. Cassette configures the multipurpose feeder as the default paper source.</li> <li>• Manual sets the multipurpose feeder only for manual-feed print jobs.</li> <li>• First sets the multipurpose feeder as the primary paper source regardless of settings.</li> </ul>

## Substitute Size menu

Use	To
<b>Substitute Size</b> Off Statement/A5 Letter/A4 All Listed	Substitute a specified paper size if the requested paper size is not available.  <b>Notes:</b> <ul style="list-style-type: none"> <li>• All Listed is the factory default setting. All available substitutions are allowed.</li> <li>• Off indicates that no size substitutions are allowed.</li> <li>• Setting a size substitution lets the print job continue without <b>Change Paper</b> appearing.</li> </ul>

## Paper Texture menu

Use	To
<b>Plain Texture</b> Smooth Normal Rough	Specify the relative texture of the plain paper loaded. <b>Note:</b> Normal is the factory default setting.
<b>Card Stock Texture</b> Smooth Normal Rough	Specify the relative texture of the card stock loaded. <b>Notes:</b> <ul style="list-style-type: none"> <li>• Normal is the factory default setting.</li> <li>• The options appear only if card stock is supported.</li> </ul>
<b>Transparency Texture</b> Smooth Normal Rough	Specify the relative texture of the transparencies loaded. <b>Note:</b> Normal is the factory default setting.
<b>Recycled Texture</b> Smooth Normal Rough	Specify the relative texture of the recycled paper loaded. <b>Note:</b> Normal is the factory default setting.

Use	To
<b>Labels Texture</b> Smooth Normal Rough	Specify the relative texture of the labels loaded. <b>Note:</b> Normal is the factory default setting.
<b>Bond Texture</b> Smooth Normal Rough	Specify the relative texture of the bond paper loaded. <b>Note:</b> Rough is the factory default setting.
<b>Envelope Texture</b> Smooth Normal Rough	Specify the relative texture of the envelopes loaded. <b>Note:</b> Normal is the factory default setting.
<b>Rough Envelope Texture</b> Rough	Specify the relative texture of the rough envelopes loaded.
<b>Letterhead Texture</b> Smooth Normal Rough	Specify the relative texture of the letterhead loaded. <b>Note:</b> Normal is the factory default setting.
<b>Preprinted Texture</b> Smooth Normal Rough	Specify the relative texture of the preprinted paper loaded. <b>Note:</b> Normal is the factory default setting.
<b>Colored Texture</b> Smooth Normal Rough	Specify the relative texture of the colored paper loaded. <b>Note:</b> Normal is the factory default setting.
<b>Light Texture</b> Smooth Normal Rough	Specify the relative texture of the paper loaded. <b>Note:</b> Normal is the factory default setting.
<b>Heavy Texture</b> Smooth Normal Rough	Specify the relative texture of the paper loaded. <b>Note:</b> Normal is the factory default setting.
<b>Rough/Cotton Texture</b> Rough	Specify the relative texture of the cotton paper loaded.
<b>Custom [x] Texture</b> Smooth Normal Rough	Specify the relative texture of the custom paper loaded. <b>Notes:</b> <ul style="list-style-type: none"> <li>• Normal is the factory default setting.</li> <li>• The options appear only if the custom type is supported.</li> </ul>

## Paper Weight menu

Use	To
<b>Plain Weight</b> Light Normal Heavy	Specify the relative weight of the plain paper loaded. <b>Note:</b> Normal is the factory default setting.
<b>Card Stock Weight</b> Light Normal Heavy	Specify the relative weight of the card stock loaded. <b>Note:</b> Normal is the factory default setting.
<b>Transparency Weight</b> Light Normal Heavy	Specify the relative weight of the transparencies loaded. <b>Note:</b> Normal is the factory default setting.
<b>Recycled Weight</b> Light Normal Heavy	Specify the relative weight of the recycled paper loaded. <b>Note:</b> Normal is the factory default setting.
<b>Labels Weight</b> Light Normal Heavy	Specify the relative weight of the labels loaded. <b>Note:</b> Normal is the factory default setting.
<b>Bond Weight</b> Light Normal Heavy	Specify the relative weight of the bond paper loaded. <b>Note:</b> Normal is the factory default setting.
<b>Envelope Weight</b> Light Normal Heavy	Specify the relative weight of the envelope loaded. <b>Note:</b> Normal is the factory default setting.
<b>Rough Envelope Weight</b> Light Normal Heavy	Specify the relative weight of the rough envelope loaded. <b>Note:</b> Normal is the factory default setting.
<b>Letterhead Weight</b> Light Normal Heavy	Specify the relative weight of the letterhead loaded. <b>Note:</b> Normal is the factory default setting.
<b>Preprinted Weight</b> Light Normal Heavy	Specify the relative weight of the preprinted paper loaded. <b>Note:</b> Normal is the factory default setting.

Use	To
<b>Colored Weight</b> Light Normal Heavy	Specify the relative weight of the colored paper loaded. <b>Note:</b> Normal is the factory default setting.
<b>Light Weight</b> Light	Specify that the weight of the paper loaded is light.
<b>Heavy Weight</b> Heavy	Specify that the weight of the paper loaded is heavy.
<b>Cotton/Rough Weight</b> Light Normal Heavy	Specify the relative weight of the cotton or rough paper loaded. <b>Note:</b> Heavy is the factory default setting.
<b>Custom [x] Weight</b> Light Normal Heavy	Specify the relative weight of the custom paper loaded. <b>Notes:</b> <ul style="list-style-type: none"> <li>• Normal is the factory default setting.</li> <li>• The options appear only when the custom type is supported.</li> </ul>

## Paper Loading menu

Use	To
<b>Recycled Loading</b> Duplex Off	Determine and set two-sided printing for all print jobs that specify Recycled as the paper type.
<b>Bond Loading</b> Duplex Off	Determine and set two-sided printing for all print jobs that specify Bond as the paper type.
<b>Letterhead Loading</b> Duplex Off	Determine and set two-sided printing for all print jobs that specify Letterhead as the paper type.
<b>Preprinted Loading</b> Duplex Off	Determine and set two-sided printing for all print jobs that specify Preprinted as the paper type.
<b>Colored Loading</b> Duplex Off	Determine and set two-sided printing for all print jobs that specify Colored as the paper type.
<b>Notes:</b> <ul style="list-style-type: none"> <li>• Duplex sets two-sided printing as the default for all print jobs unless one-sided printing is set from Printing Preferences or Print dialog.</li> <li>• If Duplex is selected, then all print jobs are sent through the duplex unit, including one-sided jobs.</li> <li>• Off is the factory default setting for all the menus.</li> </ul>	



Use	To
<b>Light Loading</b> Duplex Off	Determine and set two-sided printing for all print jobs that specify Light as the paper type.
<b>Heavy Loading</b> Duplex Off	Determine and set two-sided printing for all print jobs that specify Heavy as the paper type.
<b>Custom [x] Loading</b> Duplex Off	Determine and set two-sided printing for all print jobs that specify Custom [x] as the paper type.  <b>Note:</b> Custom [x] Loading is available only if the custom type is supported.
<b>Notes:</b> <ul style="list-style-type: none"> <li>• Duplex sets two-sided printing as the default for all print jobs unless one-sided printing is set from Printing Preferences or Print dialog.</li> <li>• If Duplex is selected, then all print jobs are sent through the duplex unit, including one-sided jobs.</li> <li>• Off is the factory default setting for all the menus.</li> </ul>	

## Custom Types menu

Use	To
<b>Custom Type [x]</b> Paper Card Stock Transparency Rough/Cotton Labels Envelope	Associate a paper or specialty media type with a Custom Type [x] name or a user-defined custom name created in the Embedded Web Server or in the Local Printer Settings Utility.  <b>Notes:</b> <ul style="list-style-type: none"> <li>• Paper is the factory default setting for Custom Type [x].</li> <li>• The specialty media type must be supported in the selected tray or feeder in order to print from that source.</li> </ul>
<b>Recycled</b> Paper Card Stock Transparency Rough/Cotton Labels Envelope	Specify a paper type when the Recycled setting is selected in other menus.  <b>Notes:</b> <ul style="list-style-type: none"> <li>• Paper is the factory default setting.</li> <li>• The Recycled paper type must be supported in the selected tray or feeder in order to print from that source.</li> </ul>

## Universal Setup menu

Use	To
<b>Units of Measure</b> Inches Millimeters	Identify the units of measure.  <b>Notes:</b> <ul style="list-style-type: none"> <li>• Inches is the US factory default setting.</li> <li>• Millimeters is the international factory default setting.</li> </ul>

Use	To
<b>Portrait Width</b> 3–8.5 inches 76–216 mm	Set the portrait width. <b>Notes:</b> <ul style="list-style-type: none"> <li>• If the width exceeds the maximum, then the printer uses the maximum width allowed.</li> <li>• 8.5 inches is the US factory default setting. You can increase the width in 0.01-inch increments.</li> <li>• 216 mm is the international factory default setting. You can increase the width in 1-mm increments.</li> </ul>
<b>Portrait Height</b> 3–14.17 inches 76–360 mm	Set the portrait height. <b>Notes:</b> <ul style="list-style-type: none"> <li>• If the height exceeds the maximum, then the printer uses the maximum height allowed.</li> <li>• 14 inches is the US factory default setting. You can increase the height in 0.01-inch increments.</li> <li>• 356 mm is the international factory default setting. You can increase the height in 1-mm increments.</li> </ul>
<b>Feed Direction</b> Short Edge Long Edge	Specify the feed direction if the paper can be loaded in either direction. <b>Notes:</b> <ul style="list-style-type: none"> <li>• Short Edge is the factory default setting.</li> <li>• Long Edge appears only when the longest edge is shorter than the maximum width supported in the tray.</li> </ul>

## Reports menu

### Reports menu

Use	To
<b>Menu Settings Page</b>	Print a report containing information about the paper loaded in trays, installed memory, total page count, alarms, timeouts, printer control panel language, TCP/IP address, status of supplies, status of the network connection, and other information.
<b>Device Statistics</b>	Print a report containing printer statistics, such as supply information and details about printed pages.
<b>Network Setup Page</b>	Print a report containing information about the network printer settings, such as the TCP/IP address information. <b>Note:</b> This menu item appears only in network printers or in printers connected to print servers.
<b>Profiles List</b>	Print a list of profiles stored in the printer. <b>Note:</b> This menu item appears only when LDSS is enabled.

Use	To
<b>Print Fonts</b> PCL Fonts PostScript Fonts	Print a report of all the fonts available for the printer language currently set in the printer. <b>Note:</b> A separate list is available for PCL and PostScript emulations.
<b>Print Directory</b>	Print a list of all the resources stored in an optional flash memory card. <b>Notes:</b> <ul style="list-style-type: none"> <li>• Job Buffer Size must be set to 100%.</li> <li>• Make sure the optional flash memory is installed correctly and working properly.</li> <li>• This menu item appears only when an optional flash memory card is installed.</li> </ul>
<b>Asset Report</b>	Print a report containing printer asset information, such as serial number and model name.

## Network/Ports menu

The menus in this section only appear in network printers or printers connected to print servers.

### Active NIC menu

Use	To
<b>Active NIC</b> Auto [list of available network cards]	<b>Notes:</b> <ul style="list-style-type: none"> <li>• Auto is the factory default setting.</li> <li>• This menu item appears only when an optional network card is installed.</li> </ul>

### Standard Network or Network [x] menu

**Note:** Only active ports appear in this menu. All inactive ports are omitted.

Use	To
<b>PCL SmartSwitch</b> On Off	Set the printer to automatically switch to PCL emulation when a print job requires it, regardless of the default printer language. <b>Notes:</b> <ul style="list-style-type: none"> <li>• On is the factory default setting.</li> <li>• If PCL SmartSwitch is disabled, then the printer does not examine incoming data and it uses the default printer language specified in the Setup menu.</li> </ul>
<b>PS SmartSwitch</b> On Off	Set the printer to automatically switch to PS emulation when a print job requires it, regardless of the default printer language. <b>Notes:</b> <ul style="list-style-type: none"> <li>• On is the factory default setting.</li> <li>• If PS SmartSwitch is disabled, then the printer does not examine incoming data and it uses the default printer language specified in the Setup menu.</li> </ul>

Use	To
<b>NPA Mode</b> Off Auto	Set the printer to perform the special processing required for bidirectional communication following the conventions defined by the NPA protocol.  <b>Notes:</b> <ul style="list-style-type: none"> <li>• Auto is the factory default setting.</li> <li>• Changing this setting from the printer control panel and then exiting the menus causes the printer to restart. The menu selection is then updated.</li> </ul>
<b>Network Buffer</b> Disabled Auto 3KB to [maximum size allowed]	Set the size of the network input buffer.  <b>Notes:</b> <ul style="list-style-type: none"> <li>• Auto is the factory default setting.</li> <li>• The value can be changed in 1-KB increments.</li> <li>• The maximum size allowed depends on the amount of memory in the printer, the size of the other link buffers, and whether Resource Save is set to On or Off.</li> <li>• To increase the maximum size range for the Network Buffer, disable or reduce the size of the parallel, serial, and USB buffers.</li> <li>• Changing this setting from the printer control panel and then exiting the menus causes the printer to restart. The menu selection is then updated.</li> </ul>
<b>Mac Binary PS</b> On Off Auto	Set the printer to process Macintosh binary PostScript print jobs.  <b>Notes:</b> <ul style="list-style-type: none"> <li>• Auto is the factory default setting.</li> <li>• Off filters print jobs using the standard protocol.</li> <li>• On processes raw binary PostScript print jobs.</li> </ul>

## Reports menu

To access the menu, navigate to either of the following:

- **Network/Ports > Standard Network > Standard Network Setup > Reports**
- **Network/Ports > Network [x] > Network [x] Setup > Reports**

Use	To
<b>Print Setup Page</b>	Print a report containing information about the network printer settings, such as the TCP/IP address.

## Network Card menu

To access the menu, navigate to either of the following:

- **Network/Ports > Standard Network > Standard Network Setup > Network Card**
- **Network/Ports > Network [x] > Network [x] Setup > Network Card**

Use	To
<b>View Card Status</b> Connected Disconnected	View the connection status of the network card.

Use	To
<b>View Card Speed</b>	View the speed of an active network card.
<b>Network Address</b> UAA LAA	View the network addresses.
<b>Job Timeout</b> 0–255 seconds	Set the amount of time it takes for a network print job to be canceled. <b>Notes:</b> <ul style="list-style-type: none"> <li>• 90 seconds is the factory default setting.</li> <li>• A setting value of 0 disables the timeout.</li> <li>• If a value of 1–9 is selected, then the setting is saved as 10.</li> </ul>

## TCP/IP menu

To access the menu, navigate to any of the following:

- **Network/Ports > Standard Network > Standard Network Setup > TCP/IP**
- **Network/Ports > Network [x] > Network [x] Setup > TCP/IP**

**Note:** This menu is available only in network printers or printers connected to print servers.

Use	To
<b>Set Hostname</b>	Set the host name. <b>Notes:</b> <ul style="list-style-type: none"> <li>• This setting can be changed only from the Embedded Web Server.</li> <li>• The host name can be up to 15 characters and can be a US-ASCII or alphanumeric character, or hyphen.</li> </ul>
<b>IP Address</b>	View or change the current TCP/IP address. <b>Note:</b> Manually setting the IP address sets the “Enable DHCP” and “Enable Auto IP” settings to Off. It also sets “Enable BOOTP” and “Enable RARP” to Off on systems that support BOOTP and RARP.
<b>Netmask</b>	View or change the current TCP/IP netmask.
<b>Gateway</b>	View or change the current TCP/IP gateway.
<b>Enable DHCP</b> On Off	Specify the DHCP address and parameter assignment. <b>Note:</b> On is the factory default setting.
<b>Enable AutoIP</b> Yes No	Specify the Zero Configuration Networking setting. <b>Note:</b> Yes is the factory default setting.
<b>Enable FTP/TFTP</b> Yes No	Enable the built-in FTP server, which lets you send files to the printer using File Transfer Protocol. <b>Note:</b> Yes is the factory default setting.

Use	To
<b>Enable HTTP Server</b> Yes No	Enable the built-in Web server (Embedded Web Server). When enabled, the printer can be monitored and managed remotely using a Web browser. <b>Note:</b> Yes is the factory default setting.
<b>WINS Server Address</b>	View or change the current WINS server address.
<b>Enable DDNS</b> Yes No	View or change the current DDNS setting. <b>Note:</b> Yes is the factory default setting.
<b>Enable mDNS</b> Yes No	View or change the current mDNS setting. <b>Note:</b> Yes is the factory default setting.
<b>DNS Server Address</b>	View or change the current DNS server address.
<b>Backup DNS Server Address</b>	View or change the backup DNS server addresses.
<b>Backup DNS Server Address 2</b>	
<b>Backup DNS Server Address 3</b>	
<b>Enable HTTPS</b> Yes No	View or change the current HTTPS setting. <b>Note:</b> Yes is the factory default setting.

## IPv6 menu

To access the menu, navigate to any of the following:

- **Network/Ports > Standard Network > Standard Network Setup > IPv6**
- **Network/Ports > Network [x] > Network [x] Setup > IPv6**

**Note:** This menu is available only in network printers or printers connected to print servers.

Use	To
<b>Enable IPv6</b> On Off	Enable Internet Protocol Version Six (IPv6) in the printer. IPv6 uses bigger numbers to create IP addresses. <b>Note:</b> On is the factory default setting.
<b>Auto Configuration</b> On Off	Specify whether or not the network adapter accepts the automatic IPv6 address configuration entries provided by a router. <b>Note:</b> On is the factory default setting.
<b>Set Hostname*</b>	Set the host name. <b>Note:</b> The host name is limited to 15 characters, and accepts US-ASCII, alphanumeric characters and hyphen only.
<b>View Address*</b>	View the current IPv6 addresses.
<b>View Router Address*</b>	View the current router address.

\* These settings can be changed only from the Embedded Web Server.

Use	To
<b>Enable DHCPv6</b> On Off	Enable DHCPv6 in the printer. <b>Note:</b> On is the factory default setting.
* These settings can be changed only from the Embedded Web Server.	

## Wireless menu

**Note:** This menu is available only in printers connected to a wireless network or printer models that have a wireless network adapter.

To access the menu, navigate to any of the following:

- **Network/Ports > Network [x] > Network [x] Setup > Wireless**

Use	To
<b>Network Mode</b> Infrastructure Ad hoc	Specify the network mode. <b>Notes:</b> <ul style="list-style-type: none"> <li>• Ad hoc is the factory default setting. This configures wireless connection directly between the printer and a computer.</li> <li>• Infrastructure lets the printer access a network using an access point.</li> </ul>
<b>Compatibility</b> 802.11b/g 802.11b/g/n	Specify the wireless standard for the wireless network. <b>Note:</b> The 802.11b/g/n is the factory default setting.
<b>Choose Network</b>	Select an available network for the printer to use.
<b>View Signal Quality</b>	View the quality of the wireless connection.
<b>View Security Mode</b>	View the encryption method for the wireless network.

## AppleTalk menu

**Note:** This menu is available only in printer models connected to a wired network or when an optional network card is installed.

To access the menu, navigate to any of the following:

- **Network/Ports > Standard Network > Standard Network Setup > AppleTalk**
- **Network/Ports > Network Setup [x] > AppleTalk**

Use	To
<b>Activate</b> Yes No	Enable or disable AppleTalk support. <b>Note:</b> Yes is the factory default setting.
<b>View Name</b>	Show the assigned AppleTalk name. <b>Note:</b> The name can be changed only from the Embedded Web Server.

Use	To
<b>View Address</b>	Show the assigned AppleTalk address. <b>Note:</b> The address can be changed only from the Embedded Web Server.
<b>Set Zone</b> [list of zones available on the network]	Provide a list of AppleTalk zones available on the network. <b>Note:</b> The factory default setting is the default zone for the network. If no default zone exists, then the zone marked with an asterisk (*) is the default setting.

## Standard USB menu

Use	To
<b>PCL SmartSwitch</b> On Off	Set the printer to automatically switch to PCL emulation when a print job received through a USB port requires it, regardless of the default printer language. <b>Notes:</b> <ul style="list-style-type: none"> <li>• On is the factory default setting.</li> <li>• When set to Off, the printer does not examine incoming data. The printer uses PostScript emulation if the PS SmartSwitch is set to On. It uses the default printer language specified in the Setup menu if the PS SmartSwitch is set to Off.</li> </ul>
<b>PS SmartSwitch</b> On Off	Set the printer to automatically switch to PS emulation when a print job received through a USB port requires it, regardless of the default printer language. <b>Notes:</b> <ul style="list-style-type: none"> <li>• On is the factory default setting.</li> <li>• When set to Off, the printer does not examine incoming data. The printer uses PCL emulation if the PCL SmartSwitch is set to On. It uses the default printer language specified in the Setup menu if the PCL SmartSwitch is set to Off.</li> </ul>
<b>NPA Mode</b> On Off Auto	Set the printer to perform the special processing required for bidirectional communication following the conventions defined by the NPA protocol. <b>Notes:</b> <ul style="list-style-type: none"> <li>• Auto is the factory default setting. Auto sets the printer to examine data, determine the format, and then process it appropriately.</li> <li>• The printer automatically restarts when changing the setting from the printer control panel. The menu selection is then updated.</li> </ul>



Use	To
<b>USB Buffer</b> Disabled Auto 3K to [maximum size allowed]	Set the size of the USB input buffer.  <b>Notes:</b> <ul style="list-style-type: none"> <li>• Auto is the factory default setting.</li> <li>• Disabled turns off job buffering.</li> <li>• The USB buffer size value can be changed in 1-KB increments.</li> <li>• The maximum size allowed depends on the amount of memory in the printer, the size of the other link buffers, and whether Resource Save is set to On or Off.</li> <li>• To increase the maximum size range for USB Buffer, disable or reduce the size of the parallel, serial, and network buffers.</li> <li>• The printer automatically restarts when the setting is changed from the printer control panel. The menu selection is then updated.</li> </ul>
<b>Mac Binary PS</b> On Off Auto	Set the printer to process Macintosh binary PostScript print jobs.  <b>Notes:</b> <ul style="list-style-type: none"> <li>• Auto is the factory default setting.</li> <li>• On processes raw binary PostScript print jobs.</li> <li>• Off filters print jobs using the standard protocol.</li> </ul>
<b>ENA Address</b> YYY.YYY.YYY.YYY	Set the network address information for an external print server.  <b>Note:</b> This menu is available only when the printer is attached to an external print server through the USB port.
<b>ENA Netmask</b> YYY.YYY.YYY.YYY	Set the netmask information for an external print server.  <b>Note:</b> This menu is available only when the printer is attached to an external print server through the USB port.
<b>ENA Gateway</b> YYY.YYY.YYY.YYY	Set the gateway information for an external print server.  <b>Note:</b> This menu is available only when the printer is attached to an external print server through the USB port.

## SMTP Setup menu

Use	To
<b>Primary SMTP Gateway</b>	Specify SMTP server gateway and port information.  <b>Note:</b> 25 is the default SMTP gateway port.
<b>Primary SMTP Gateway Port</b>	
<b>Secondary SMTP Gateway</b>	
<b>Secondary SMTP Gateway Port</b>	
<b>SMTP Timeout</b> 5–30	Specify the amount of time in seconds before the server stops trying to send an e-mail.  <b>Note:</b> 30 seconds is the factory default setting.
<b>Reply Address</b>	Specify a reply address of up to 128 characters in the e-mail sent by the printer.

Use	To
<b>Use SSL</b> Disabled Negotiate Required	Set the printer to use SSL for increased security when connecting to the SMTP server.  <b>Notes:</b> <ul style="list-style-type: none"> <li>• Disabled is the factory default setting.</li> <li>• When the Negotiate setting is used, the SMTP server determines if SSL will be used.</li> </ul>
<b>SMTP Server Authentication</b> No authentication required Login/Plain CRAM-MD5 Digest-MD5 NTLM Kerberos 5	Specify the type of user authentication required for printing privileges.  <b>Note:</b> “No authentication required” is the factory default setting.
<b>Device-Initiated E-mail</b> None Use Device SMTP Credentials	Specify what credentials will be used when communicating to the SMTP server. Some SMTP servers require credentials to send an e-mail.  <b>Notes:</b> <ul style="list-style-type: none"> <li>• None is the factory default setting for Device-Initiated E-mail.</li> <li>• Device Userid and Device Password are used to log in to the SMTP server when Use Device SMTP Credentials is selected.</li> </ul>
<b>Device Userid</b>	
<b>Device Password</b>	

## Security menu

### Security Audit Log menu

Use	To
<b>Export Log</b>	Let an authorized user export the audit log.  <b>Notes:</b> <ul style="list-style-type: none"> <li>• To export the audit log from the printer control panel, connect a flash drive to the printer.</li> <li>• You can also download the audit log from the Embedded Web Server, and then save it on your computer.</li> </ul>
<b>Delete Log</b> Delete now Do not delete	Specify whether or not audit logs are deleted.  <b>Note:</b> Delete now is the factory default setting.

Use	To
<b>Configure Log</b> Enable Audit Yes No Enable Remote Syslog No Yes Remote Syslog Facility 0–23 Severity of events to log 0–7	Specify how and whether or not audit logs are created. <b>Notes:</b> <ul style="list-style-type: none"> <li>• Enable Audit determines if events are recorded in the secure audit log and remote syslog. No is the factory default setting.</li> <li>• Enable Remote Syslog determines if logs are sent to a remote server. No is the factory default setting.</li> <li>• Remote Syslog Facility determines the value used to send logs to the remote syslog server. 4 is the factory default setting.</li> <li>• If the security audit log is activated, then the severity value of each event is recorded. 4 is the factory default setting.</li> </ul>

## Set Date and Time menu

Use	To
<b>Current Date and Time</b>	View the current date and time settings for the printer. <b>Note:</b> The date and time are set in YYYY-MM-DD HH:MM format.
<b>Manually Set Date and Time</b> [input date/time]	Enter the date and time. <b>Note:</b> Setting the date and time using this menu automatically sets Enable NTP to Off.
<b>Time Zone</b> [list of time zones]	Select the time zone. <b>Note:</b> GMT is the factory default setting.
<b>Automatically observe DST</b> On Off	Set the printer to use the applicable daylight saving time (DST) start and end times associated with the printer Time Zone setting. <b>Note:</b> On is the factory default setting.
<b>Enable NTP</b> On Off	Enable Network Time Protocol, which synchronizes the clocks of devices on a network. <b>Notes:</b> <ul style="list-style-type: none"> <li>• On is the factory default setting.</li> <li>• Enable NTP is automatically set to Off if you manually set the date and time.</li> </ul>

# Settings menu

## General Settings menu

Use	To
<p><b>Display Language</b></p> <ul style="list-style-type: none"> <li>English</li> <li>Francais</li> <li>Deutsch</li> <li>Italiano</li> <li>Espanol</li> <li>Dansk</li> <li>Norsk</li> <li>Nederlands</li> <li>Svenska</li> <li>Portuguese</li> <li>Suomi</li> <li>Russian</li> <li>Polski</li> <li>Greek</li> <li>Magyar</li> <li>Turkce</li> <li>Cesky</li> <li>Simplified Chinese</li> <li>Traditional Chinese</li> <li>Korean</li> <li>Japanese</li> </ul>	<p>Set the language of the text appearing on the display.</p> <p><b>Note:</b> Not all languages are available for all printers, and you may need to install special hardware for those languages to appear.</p>
<p><b>Show Supply Estimates</b></p> <ul style="list-style-type: none"> <li>Show estimates</li> <li>Do not show estimates</li> </ul>	<p>View the estimates of the supplies on the control panel, Embedded Web Server, menu settings, and the device statistics reports.</p>
<p><b>Eco-Mode</b></p> <ul style="list-style-type: none"> <li>Off</li> <li>Energy</li> <li>Energy/Paper</li> <li>Paper</li> </ul>	<p>Minimize the use of energy, paper, or specialty media.</p> <p><b>Notes:</b></p> <ul style="list-style-type: none"> <li>• Off is the factory default setting. This resets the printer to its factory default settings.</li> <li>• Energy minimizes the power used by the printer.</li> <li>• Energy/Paper minimizes the use of power and of paper and specialty media.</li> <li>• Paper minimizes the amount of paper and specialty media needed for a print job.</li> </ul>
<p><b>Quiet Mode</b></p> <ul style="list-style-type: none"> <li>Off</li> <li>On</li> </ul>	<p>Minimize the printer noise.</p> <p><b>Note:</b> Off is the factory default setting.</p>

Use	To
<p><b>Run Initial setup</b></p> <p>Yes</p> <p>No</p>	<p>Run the setup wizard.</p> <p><b>Notes:</b></p> <ul style="list-style-type: none"> <li>• Yes is the factory default setting.</li> <li>• After completing the setup wizard by selecting Done at the country or region selection screen, the default becomes No.</li> </ul>
<p><b>Paper Sizes</b></p> <p>US</p> <p>Metric</p>	<p>Specify the unit of measurement for paper sizes.</p> <p><b>Notes:</b></p> <ul style="list-style-type: none"> <li>• US is the factory default setting.</li> <li>• The initial setting is determined by your country or region selection in the initial setup wizard.</li> </ul>
<p><b>Timeouts</b></p> <p>Sleep Mode</p> <p>Disabled</p> <p>1–120 min</p>	<p>Set the amount of time the printer waits after a job is printed before it goes into a reduced power state.</p> <p><b>Notes:</b></p> <ul style="list-style-type: none"> <li>• 30 min is the factory default setting.</li> <li>• Disabled appears only when Energy Conserve is set to Off.</li> <li>• The maximum amount of time is increased to 240 minutes when Energy Conserve is set to Off.</li> <li>• Lower settings conserve more energy, but may require longer warm-up times.</li> <li>• Select a high setting if the printer is in constant use. Under most circumstances, this keeps the printer ready to print with minimum warm-up time.</li> </ul>
<p><b>Timeouts</b></p> <p>Print with Display Off</p> <p>Allow printing with display off</p> <p>Display on when printing</p>	<p>Print a job while the display is off.</p> <p><b>Note:</b> Display on when printing is the factory default setting.</p>
<p><b>Timeouts</b></p> <p>Hibernate Timeout</p> <p>Disabled</p> <p>1 hour</p> <p>2 hours</p> <p>3 hours</p> <p>6 hours</p> <p>1 day</p> <p>2 days</p> <p>3 days</p> <p>1 week</p> <p>2 weeks</p> <p>1 month</p>	<p>Set the amount of time the printer waits before it enters Hibernate mode.</p> <p><b>Note:</b> 3 days is the factory default setting.</p>

Use	To
<b>Timeouts</b> Hibernate Timeout on Connection Hibernate Do Not Hibernate	Set the printer to Hibernate mode even if there is an active Ethernet connection. <b>Note:</b> Do Not Hibernate is the factory default setting.
<b>Timeouts</b> Screen Timeout 15–300 sec	Set the amount of time in seconds the printer waits before the it returns to a ready state. <b>Note:</b> 30 sec is the factory default setting.
<b>Timeouts</b> Print Timeout Disabled 1–255 sec	Set the amount of time in seconds the printer waits to receive an end-of-job message before canceling the remainder of the print job. <b>Notes:</b> <ul style="list-style-type: none"> <li>• 90 sec is the factory default setting.</li> <li>• When the timer expires, any partially printed page still in the printer is printed, and then the printer checks to see if any new print jobs are waiting.</li> <li>• Print Timeout is available only when using PCL emulation. This setting has no effect on PostScript emulation print jobs.</li> </ul>
<b>Timeouts</b> Wait Timeout Disabled 15–65535 sec	Set the amount of time in seconds the printer waits for additional data before canceling a print job. <b>Note:</b> 40 sec is the factory default setting.
<b>Error Recovery</b> Auto Reboot Reboot when idle Reboot always Reboot never Max Auto Reboots 1–20	Set the printer to restart when an error is encountered. <b>Notes:</b> <ul style="list-style-type: none"> <li>• Reboot always is the factory default setting for Auto Reboot.</li> <li>• 2 is the factory default setting for Max Auto Reboots.</li> <li>• If the printer performs the same number of automatic reboots that is set in the printer within a certain amount of time, then the printer shows the applicable error instead of rebooting.</li> </ul>
<b>Print Recovery</b> Auto Continue Disabled 5–255 sec	Let the printer automatically continue printing from certain offline situations when these are not resolved within the specified time period. <b>Note:</b> Disabled is the factory default setting.

Use	To
<p><b>Print Recovery</b>                      Jam Recovery                          On                          Off                          Auto</p> <p><b>Print Recovery</b>                      Jam Assist                          On                          Off</p> <p><b>Print Recovery</b>                      Page Protect                          Off                          On</p>	<p>Specify whether the printer reprints jammed pages.</p> <p><b>Notes:</b></p> <ul style="list-style-type: none"> <li>• Auto is the factory default setting. The printer reprints jammed pages unless the memory required to hold the pages is needed for other printer tasks.</li> <li>• On sets the printer to always reprint jammed pages.</li> <li>• Off sets the printer to never reprint jammed pages.</li> </ul> <hr/> <p><b>Notes:</b></p> <ul style="list-style-type: none"> <li>• On is the factory default setting. This sets the printer to automatically dump blank pages or partially printed pages to the standard bin after a jammed page has been cleared.</li> <li>• Off requires the user to remove all pages from all possible jam locations.</li> </ul> <hr/> <p>Successfully print a page that may not have printed otherwise.</p> <p><b>Notes:</b></p> <ul style="list-style-type: none"> <li>• Off is the factory default setting. This prints a partial page when there is not enough memory to print the whole page.</li> <li>• On sets the printer to process the whole page so that the entire page prints.</li> </ul>
<p><b>Press Sleep Button</b>                      Do nothing                      Sleep                      Hibernate</p>	<p>Determine how the printer, while in idle state, reacts to a short press of the Sleep button.</p> <p><b>Note:</b> Sleep is the factory default setting.</p>
<p><b>Press and Hold Sleep Button</b>                      Do nothing                      Sleep                      Hibernate</p>	<p>Determine how the printer, while in idle state, reacts to a long press of the Sleep button.</p> <p><b>Note:</b> Do nothing is the factory default setting.</p>
<p><b>Factory Defaults</b>                      Do Not Restore                      Restore Now</p>	<p>Use the printer factory default settings.</p> <p><b>Notes:</b></p> <ul style="list-style-type: none"> <li>• Do Not Restore is the factory default setting. This retains the user-defined settings.</li> <li>• Restore Now sets all printer settings to the factory default settings except Network/Ports menu settings. All downloads stored in the RAM are deleted. Downloads stored in the flash memory are not affected.</li> </ul>

Use	To
<b>Custom Home Message</b> Off IP Address Hostname Contact Name Location Zero Configuration Name Custom Text 1	Select a custom home message that appears as an alternating display of the printer status.  <b>Note:</b> Off is the factory default setting.

## Print Settings

### Setup menu

Use	To
<b>Printer Language</b> PCL Emulation PS Emulation	Set the default printer language.  <b>Notes:</b> <ul style="list-style-type: none"> <li>• PCL Emulation is the factory default setting.</li> <li>• PostScript emulation uses a PostScript interpreter for processing print jobs.</li> <li>• PCL Emulation uses a PCL interpreter for processing print jobs.</li> <li>• Setting a printer language default does not prevent a software program from sending print jobs that use another printer language.</li> </ul>
<b>Print Area</b> Normal Whole Page	Set the logical and physical printable area.  <b>Notes:</b> <ul style="list-style-type: none"> <li>• Normal is the factory default setting. When attempting to print data on the non-printable area defined by the Normal setting, the printer clips the image at the boundary.</li> <li>• Whole Page allows the image to be moved into the non-printable area defined by the Normal setting. This setting affects only pages printed using a PCL 5 interpreter and has no effect on pages printed using the PCL XL or PostScript interpreter.</li> </ul>
<b>Download Target</b> RAM Flash	Set the storage location for downloads.  <b>Notes:</b> <ul style="list-style-type: none"> <li>• RAM is the factory default setting. Storing downloads in the RAM is temporary.</li> <li>• Storing downloads in a flash memory places them in permanent storage. Downloads remain in the flash memory even when the printer is turned off.</li> <li>• This menu item appears only when an optional flash memory is installed.</li> </ul>



Use	To
<b>Resource Save</b> On Off	Specify how the printer handles temporary downloads, such as fonts and macros stored in the RAM, when the printer receives a print job that requires more than the available memory.  <b>Notes:</b> <ul style="list-style-type: none"> <li>• Off is the factory default setting. Off sets the printer to retain downloads only until memory is needed. Downloads are deleted in order to process print jobs.</li> <li>• On sets the printer to retain downloads during language changes and printer resets. If the printer runs out of memory, then <b>Memory Full [38]</b> appears on the printer display, but downloads are not deleted.</li> </ul>

## Finishing menu

Use	To
<b>Sides (Duplex)</b> 1 sided 2 sided	Specify whether two-sided (duplex) printing is set as the default for all print jobs.  <b>Notes:</b> <ul style="list-style-type: none"> <li>• “1 sided” is the factory default setting.</li> <li>• You can set two-sided printing from the software program.</li> </ul> For Windows users: <ol style="list-style-type: none"> <li>1 Click <b>File &gt; Print</b>.</li> <li>2 Click <b>Properties, Preferences, Options, or Setup</b>.</li> </ol> For Macintosh users: <ol style="list-style-type: none"> <li>1 Choose <b>File &gt; Print</b>.</li> <li>2 Adjust the settings from the print dialog and pop-up menus.</li> </ol>
<b>Duplex Binding</b> Long Edge Short Edge	Define the way two-sided pages are bound and printed.  <b>Notes:</b> <ul style="list-style-type: none"> <li>• Long Edge is the factory default setting. Long Edge binds pages along their long edge (left edge for portrait and top edge for landscape).</li> <li>• Short Edge binds pages along their short edge (top edge for portrait and left edge for landscape).</li> </ul>
<b>Copies</b> 1–999	Specify the default number of copies for each print job.  <b>Note:</b> 1 is the factory default setting.
<b>Blank Pages</b> Do Not Print Print	Specify whether to insert blank pages in a print job.  <b>Note:</b> Do Not Print is the factory default setting.
<b>Collate</b> (1,1,1) (2,2,2) (1,2,3) (1,2,3)	Stack the pages of a print job in sequence when printing multiple copies.  <b>Note:</b> “(1,2,3) (1,2,3)” is the factory default setting.

Use	To
<b>Separator Sheets</b> Off Between Copies Between Jobs Between Pages	Specify whether to insert blank separator sheets. <b>Notes:</b> <ul style="list-style-type: none"> <li>• Off is the factory default setting.</li> <li>• Between Copies inserts a blank sheet between each copy of a print job if Collate is set to (1,1,1) (2,2,2). If Collate is set to (1,2,3) (1,2,3), then a blank page is inserted between each set of printed pages, such as after all page 2's and after all page 3's.</li> <li>• Between Jobs inserts a blank sheet between print jobs.</li> <li>• Between Pages inserts a blank sheet between each page of a print job. This setting is useful when printing transparencies or when inserting blank pages in a document.</li> </ul>
<b>Separator Source</b> Tray [x] Multi-Purpose Feeder	Specify the paper source for separator sheets. <b>Note:</b> Tray 1 (standard tray) is the factory default setting.
<b>Paper Saver</b> Off 2-Up 3-Up 4-Up 6-Up 9-Up 12-Up 16-Up	Print multiple-page images on one side of a paper. <b>Notes:</b> <ul style="list-style-type: none"> <li>• Off is the factory default setting.</li> <li>• The number selected is the number of page images that will print per side.</li> </ul>
<b>Paper Saver Ordering</b> Horizontal Reverse Horizontal Reverse Vertical Vertical	Specify the positioning of multiple-page images when using Paper Saver. <b>Notes:</b> <ul style="list-style-type: none"> <li>• Horizontal is the factory default setting.</li> <li>• Positioning depends on the number of page images and whether they are in portrait or landscape orientation.</li> </ul>
<b>Paper Saver Orientation</b> Auto Landscape Portrait	Specify the orientation of a multiple-page document. <b>Note:</b> Auto is the factory default setting. The printer chooses between portrait and landscape.
<b>Paper Saver Border</b> None Solid	Print a border when using Paper Saver. <b>Note:</b> None is the factory default setting.

## Quality menu

Use	To
<b>Print Resolution</b> 300 dpi 600 dpi 1200 dpi 1200 Image Q 2400 Image Q	Specify the printed output resolution in dots per inch. <b>Note:</b> 600 dpi is the factory default setting.
<b>Pixel Boost</b> Off Fonts Horizontally Vertically Both directions Isolated	Enable more pixels to print in clusters for clarity, in order to enhance images horizontally or vertically, or to enhance fonts. <b>Note:</b> Off is the factory default setting.
<b>Toner Darkness</b> 1–10	Lighten or darken the printed output. <b>Notes:</b> <ul style="list-style-type: none"> <li>• 8 is the factory default setting.</li> <li>• Selecting a smaller number can help conserve toner.</li> </ul>
<b>Enhance Fine Lines</b> On Off	Enable a print mode preferable for files such as architectural drawings, maps, electrical circuit diagrams, and flow charts. <b>Notes:</b> <ul style="list-style-type: none"> <li>• Off is the factory default setting.</li> <li>• You can set this option from the printer software. For Windows users, click <b>File &gt; Print</b>, and then click <b>Properties, Preferences, Options, or Setup</b>. For Macintosh users, choose <b>File &gt; Print</b>, and then adjust the settings from the Print dialog and pop-up menus.</li> <li>• To set this option using the Embedded Web Server, type the network printer IP address in the Web browser address field.</li> </ul>
<b>Gray Correction</b> Auto Off	Automatically adjust the contrast enhancement applied to images. <b>Note:</b> Auto is the factory default setting.
<b>Brightness</b> -6 to 6	Adjust the printed output either by lightening or darkening it. You can conserve toner by lightening the output. <b>Note:</b> 0 is the factory default setting.
<b>Contrast</b> 0–5	Adjust the contrast of printed objects. <b>Note:</b> 0 is the factory default setting.

## Utilities menu

Use	To
<b>Format Flash</b> Yes No	Format the flash memory. <b>Warning—Potential Damage:</b> Do not turn off the printer while the flash memory is being formatted. <b>Notes:</b> <ul style="list-style-type: none"> <li>Flash memory refers to the memory added by installing a flash memory card in the printer.</li> <li>Yes deletes all data stored in the flash memory.</li> <li>No cancels the format request.</li> <li>The flash memory option card must not be read/write- or write-protected.</li> <li>This menu item appears only when a non-defective flash memory card is installed.</li> </ul>
<b>Hex Trace</b>	Assist in isolating the source of a print job problem. <b>Notes:</b> <ul style="list-style-type: none"> <li>When activated, all data sent to the printer is printed in hexadecimal and character representation, and control codes are not executed.</li> <li>To exit or deactivate Hex Trace, turn off or reset the printer.</li> </ul>
<b>Coverage Estimator</b> Off On	Provide an estimate of the percentage coverage of toner on a page. The estimate is printed on a separate page at the end of each print job. <b>Note:</b> Off is the factory default setting.

## XPS menu

Use	To
<b>Print Error Pages</b> Off On	Print a page containing information on errors, including XML markup errors. <b>Note:</b> Off is the factory default setting.

## PostScript menu

Use	To
<b>Print PS Error</b> On Off	Print a page containing the PostScript error. <b>Note:</b> Off is the factory default setting.
<b>Lock PS Startup Mode</b> On Off	Disable the SysStart file. <b>Note:</b> Off is the factory default setting.

Use	To
<b>Font Priority</b> Resident Flash	Establish the font search order. <b>Notes:</b> <ul style="list-style-type: none"> <li>• Resident is the factory default setting.</li> <li>• This menu item is available only when a formatted flash memory card is installed and operating properly.</li> <li>• Make sure the flash memory card is not read/write-, write-, or password-protected.</li> <li>• Job Buffer Size must not be set to 100%.</li> </ul>

## PCL Emul menu

Use	To
<b>Font Source</b> Resident Download Flash All	Specify the set of fonts used by the Font Name menu. <b>Notes:</b> <ul style="list-style-type: none"> <li>• “Resident” is the factory default setting. “Resident” shows the factory default set of fonts downloaded in the RAM.</li> <li>• “Download” shows all the fonts downloaded in the RAM.</li> <li>• “Flash” shows all fonts resident in that option. The optional flash memory card must be properly formatted and cannot be read/write-, write-, or password-protected.</li> <li>• “All” shows all fonts available to any option.</li> </ul>
<b>Font Name</b> Courier 10	Identify a specific font and the option where it is stored. <b>Note:</b> Courier 10 is the factory default setting. Courier 10 shows the font name, font ID, and the storage location in the printer. The font source abbreviation is R for Resident, F for Flash, and D for Download.
<b>Symbol Set</b> 10U PC-8 12U PC-850	Specify the symbol set for each font name. <b>Notes:</b> <ul style="list-style-type: none"> <li>• 10U PC-8 is the US factory default setting. 12U PC-850 is the international factory default setting.</li> <li>• A symbol set is a set of alphabetic and numeric characters, punctuation, and special symbols. Symbol sets support the different languages or specific program, such as math symbols for scientific text. Only the supported symbol sets are shown.</li> </ul>
<b>PCL Emulation Settings</b> Point Size 1.00–1008.00	Change the point size for scalable typographic fonts. <b>Notes:</b> <ul style="list-style-type: none"> <li>• 12 is the factory default setting.</li> <li>• Point size refers to the height of the characters in the font. One point equals approximately 0.014 inch.</li> <li>• Point sizes can be increased or decreased in 0.25-point increments.</li> </ul>

Use	To
<b>PCL Emulation Settings</b> Pitch 0.08–100	Specify the font pitch for scalable monospaced fonts. <b>Notes:</b> <ul style="list-style-type: none"> <li>• 10 is the factory default setting.</li> <li>• Pitch refers to the number of fixed-space characters per inch (dpi).</li> <li>• Pitch can be increased or decreased in 0.01-dpi increments.</li> <li>• For nonscalable monospaced fonts, the pitch appears on the display but it cannot be changed.</li> </ul>
<b>PCL Emulation Settings</b> Orientation Portrait Landscape	Specify the orientation of text and graphics on the page. <b>Notes:</b> <ul style="list-style-type: none"> <li>• Portrait is the factory default setting. Portrait prints text and graphics parallel to the short edge of the page.</li> <li>• Landscape prints text and graphics parallel to the long edge of the page.</li> </ul>
<b>PCL Emulation Settings</b> Lines per Page 1–255	Specify the number of lines that print on each page. <b>Notes:</b> <ul style="list-style-type: none"> <li>• 60 is the US factory default setting. 64 is the international default setting.</li> <li>• The printer sets the amount of space between each line based on the Lines per Page, Paper Size, and Orientation settings. Select the Paper Size and Orientation you want before setting Lines per Page.</li> </ul>
<b>PCL Emulation Settings</b> A4 Width 198 mm 203 mm	Set the printer to print on A4-size paper. <b>Notes:</b> <ul style="list-style-type: none"> <li>• 198 mm is the factory default setting.</li> <li>• The 203-mm setting sets the width of the page to allow printing of eighty 10-pitch characters.</li> </ul>
<b>PCL Emulation Settings</b> Auto CR after LF On Off	Specify whether the printer automatically performs a carriage return (CR) after a line feed (LF) control command. <b>Note:</b> Off is the factory default setting.
<b>PCL Emulation Settings</b> Auto LF after CR On Off	Specify whether the printer automatically performs a line feed (LF) after a carriage return (CR) control command. <b>Note:</b> Off is the factory default setting.

Use	To
<p><b>Tray Renumber</b></p> <p>Assign MP Feeder                      Off                      None                      0–199</p> <p>Assign Tray [x]                      Off                      None                      0–199</p> <p>Assign Manual Paper                      Off                      None                      0–199</p> <p>Assign Manual Env                      Off                      None                      0–199</p>	<p>Configure the printer to work with printer software or programs that use different source assignments for trays and feeders.</p> <p><b>Notes:</b></p> <ul style="list-style-type: none"> <li>• Off is the factory default setting.</li> <li>• None cannot be selected. It is only displayed when it is selected by the PCL 5 interpreter. It also ignores the Select Paper Feed command.</li> <li>• 0–199 allows a custom setting to be assigned.</li> </ul>
<p><b>Tray Renumber</b></p> <p>View Factory Defaults</p> <p>MPF Default = 8                      T1 Default = 1                      T1 Default = 4                      T1 Default = 5                      T1 Default = 20                      T1 Default = 21                      Env Default = 6                      MPaper Default = 2                      MEnv Default = 3</p>	<p>Display the factory default setting assigned to each tray or feeder.</p>
<p><b>Tray Renumber</b></p> <p>Restore Defaults</p> <p>Yes                      No</p>	<p>Restore all tray and feeder assignments to their factory default settings.</p>

# Saving money and the environment

## Saving paper and toner

Studies show that as much as 80% of the carbon footprint of a printer is related to paper usage. You can significantly reduce your carbon footprint by using recycled paper and the following printing suggestions, such as printing on both sides of the paper and printing multiple pages on one side of a single sheet of paper.

For information on how you can quickly save paper and energy using one printer setting, see [“Using Eco-Mode” on page 80](#).

## Conserving supplies

### Use both sides of the paper

If your printer model supports two-sided printing, then you can control whether print appears on one or two sides of the paper.

#### Notes:

- Two-sided printing is the default setting in the print driver.
- For a complete list of supported products and countries, go to [www.dell.com/support](http://www.dell.com/support).

### Place multiple pages on one sheet of paper

You can print up to 16 consecutive pages of a multiple-page document onto one side of a single sheet of paper by setting multiple page printing (N-Up) for the print job.

### Check your first draft for accuracy

Before printing or making multiple copies of a document:

- Use the preview feature to see how the document looks like before you print it.
- Print one copy of the document to check its content and format for accuracy.

### Avoid paper jams

Correctly set the paper type and size to avoid paper jams. For more information, see [“Avoiding jams” on page 97](#).

## Saving energy

### Using Eco-Mode

Use Eco-Mode to quickly select one or more ways to reduce your printer's environmental impact.

- 1 From the printer control panel, navigate to:

 > Settings >  > General Settings >  > Eco-Mode >  > select the setting you want



Use	To
Off	Use the factory default settings for all settings associated with Eco-Mode. This setting supports the performance specifications for your printer.
Energy	Reduce energy use, especially when the printer is idle. <ul style="list-style-type: none"> <li>• Printer engine motors do not start until a document is ready to print. You may notice a short delay before the first page is printed.</li> <li>• The printer enters Sleep mode after one minute of inactivity.</li> </ul>
Energy/Paper	Use all the settings associated with Energy and Paper modes.
Paper	<ul style="list-style-type: none"> <li>• Enable the automatic two-sided (duplex) printing feature.</li> <li>• Turn off print log features.</li> </ul>

2 Press .

## Adjusting Sleep mode

To save energy, decrease the number of minutes before the printer enters Sleep mode.







Available settings range from 1 to 120 minutes. The factory default setting is 30 minutes.

**Note:** Sleep mode can be scheduled. For more information, see [“Using Schedule Power Modes” on page 82](#).

### Using the Embedded Web Server

- 1 From the Embedded Web Server, click **Settings > General Settings > Timeouts**.
- 2 In the Sleep Mode field, enter the number of minutes you want the printer to wait before it enters Sleep mode.
- 3 Click **Submit**.

### Using the printer control panel

- 1 From the printer control panel, navigate to:
 > **Settings** >  > **General Settings** >  > **Timeouts** >  > **Sleep Mode** > 
- 2 In the Sleep Mode field, select the number of minutes you want the printer to wait before it enters Sleep mode.
- 3 Press .

## Using Hibernate mode

Hibernate is an ultra-low-power saving mode.

### Notes:

- Three days is the default amount of time before the printer enters Hibernate mode.
- Make sure to wake the printer from Hibernate mode before sending a print job. A hard reset or a long press of the Sleep button wakes the printer from Hibernate mode.
- If the printer is in Hibernate mode, then the Embedded Web Server is disabled.

1 From the control panel, navigate to:



2 Press **Press Sleep Button** or **Press and Hold Sleep Button**, and then press .

3 Press **Hibernate** > .

## Setting Hibernate Timeout

Hibernate Timeout lets you set the amount of time the printer waits after a print job is processed before it goes into a reduced power state.

### Using the Embedded Web Server

1 Open a Web browser, and then type the printer IP address in the address field.

#### Notes:

- Print a network setup page or menu settings page, and then locate the IP address in the TCP/IP section. The IP address appears as four sets of numbers separated by periods, such as 123.123.123.123.
- If you are using a proxy server, then temporarily disable it to load the Web page correctly.

2 Click **Settings > General Settings > Timeouts**.

3 From the Hibernate Timeout menu, select the number of hours, days, weeks, or months you want for the printer to wait before it goes into a reduced power state.

4 Click **Submit**.

### Using the printer settings on the computer

Depending on your operating system, access the Hibernate Timeout menu using the Local Printer Settings Utility or Print Settings.

## Using Schedule Power Modes

Schedule Power Modes lets the user schedule when the printer goes into a reduced power state or into the Ready state.

### Using the Embedded Web Server

1 Open a Web browser, and then type the printer IP address in the address field.

**Notes:**

- Print a network setup page or menu settings page, and then locate the IP address in the TCP/IP section. The IP address appears as four sets of numbers separated by periods, such as 123.123.123.123.
- If you are using a proxy server, then temporarily disable it to load the Web page correctly.

**2** Click **Settings > General Settings > Schedule Power Modes**.

**3** From the Action menu, select the power mode.

**4** From the Time menu, select the time.

**5** From the Day(s) menu, select the day or days.

**6** Click **Add**.

**Using the printer settings on the computer (Windows only)**

- Access the Schedule Power Modes menu using the Local Printer Settings Utility.

## Recycling

### Recycling Dell products

To return Dell products for recycling:

- 1** Visit our Web site at [www.dell.com/recycle](http://www.dell.com/recycle).
- 2** Select your country or region.
- 3** Follow the instructions on the computer screen.

# Securing the printer

## Using the security lock feature

The printer is equipped with a security lock feature. Attach a security lock compatible with most laptop computers in the location shown to secure the printer in place.



## Statement of Volatility

Your printer contains various types of memory that can store device and network settings, and user data.

Type of memory	Description
Volatile memory	Your printer uses standard <i>random access memory</i> (RAM) to temporarily buffer user data during simple print jobs.
Non-volatile memory	Your printer may use two forms of non-volatile memory: EEPROM and NAND (flash memory). Both types are used to store operating system, device settings, and network information.

Erase the content of any installed printer memory in the following circumstances:

- The printer is being decommissioned.
- The printer is being moved to a different department or location.
- The printer is being serviced by someone from outside your organization.
- The printer is being removed from your premises for service.
- The printer is being sold to another organization.

## Erasing volatile memory

The volatile memory (RAM) installed in your printer requires a power source to retain information. To erase the buffered data, simply turn off the printer.

## Erasing non-volatile memory

- 1 Turn off the printer.
- 2 From the printer control panel, hold down **OK** and the right arrow button while turning the printer on. Release the buttons only when the Configuration menu appears.
- 3 Press the arrow buttons until **Wipe All Settings** appears, and then press **OK**.

The printer will restart several times during this process.

**Note:** Wipe All Settings securely removes device settings, solutions, jobs, and passwords from the printer memory.

- 4 Press the arrow buttons until **Exit Config Menu** appears, and then press **OK**.

The printer will perform a power-on reset, and then return to normal operating mode.

## Finding printer security information

In high-security environments, you may need to take additional steps to make sure that confidential data stored in the printer cannot be accessed by unauthorized persons. For more information, check the *Embedded Web Server—Security: Administrator's Guide* from your printer CD or from our Web site, or contact the place where you purchased the printer.

# Maintaining the printer

Periodically, certain tasks are required to maintain the optimum performance of your printer.

**Warning—Potential Damage:** Failure to replace parts and supplies when directed may cause damage to your printer or prevent the printer from performing optimally.

## Cleaning the printer

**Note:** You may need to perform this task after every few months.

**Warning—Potential Damage:** Damage to the printer caused by improper handling is not covered by the printer warranty.

- 1 Make sure that the printer is turned off and unplugged from the electrical outlet.



**CAUTION—SHOCK HAZARD:** To avoid the risk of electrical shock when cleaning the exterior of the printer, unplug the power cord from the electrical outlet and disconnect all cables from the printer before proceeding.

- 2 Remove paper from the standard bin and multipurpose feeder.
- 3 Remove any dust, lint, and pieces of paper around the printer using a soft brush or vacuum.
- 4 Dampen a clean, lint-free cloth with water, and use it to wipe the outside of the printer.

**Warning—Potential Damage:** Do not use household cleaners or detergents to prevent damage to the exterior of the printer.

- 5 Make sure all areas of the printer are dry before sending a new print job.

## Checking the status of parts and supplies

### Using the Embedded Web Server

- 1 Open a Web browser, and then type the printer IP address in the address field.

**Notes:**

- View the printer IP address in the TCP/IP section in the Network/Ports menu. The IP address appears as four sets of numbers separated by periods, such as 123.123.123.123.
- If you are using a proxy server, then temporarily disable it to load the Web page correctly.

- 2 Click **Device Status** > **More Details**.

### Using the printer control panel

From the printer control panel, navigate to:



**Note:** You can view the status of parts and supplies in the “Supply Information” section of the pages printed.

## Estimated number of remaining pages

The estimated number of remaining pages is based on the recent printing history of the printer. Its accuracy may vary significantly and is dependent on many factors, such as actual document content, print quality settings, and other printer settings.

The accuracy of the estimated number of remaining pages may decrease when the actual printing consumption is different from the historical printing consumption. Consider the variable level of accuracy before purchasing or replacing supplies based on the estimate. Until an adequate print history is obtained on the printer, initial estimates assume future supplies consumption based on the International Organization for Standardization\* test methods and page content.

\* Average continuous black declared cartridge yield in accordance with ISO/IEC 19752.

## Ordering supplies

### Ordering supplies using the Supplies Ordering Utility

- 1 Use the Search command on the Start menu to locate Status Monitor Center.
- 2 Open the application, and then click **Order Supplies**.

### Ordering supplies using Printer Home

- 1 Use the Search command on the Start menu to locate Dell Printer Home.
- 2 Open the application, and then click **Maintenance > Order supplies**.

## Storing supplies

Choose a cool, clean storage area for the printer supplies. Store supplies right side up in their original packing until you are ready to use them.

Do not expose supplies to:

- Direct sunlight
- Temperatures above 35°C (95°F)
- High humidity above 80%
- Salty air
- Corrosive gases
- Heavy dust

## Replacing supplies

### Replacing the toner cartridge

- 1 Press the button on the right side of the printer, and then open the front door.

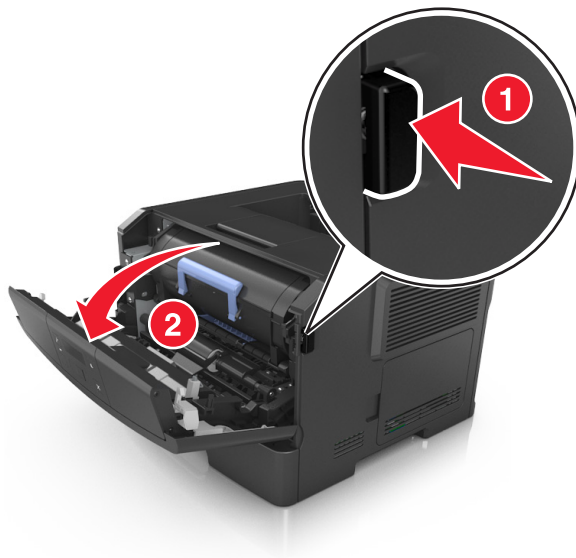

- 2 Pull the toner cartridge out using the handle.



- 3 Unpack the toner cartridge, and then remove all packing materials.
- 4 Shake the new cartridge to redistribute the toner.

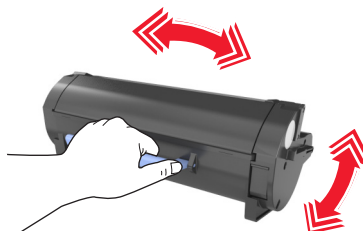



- 5 Insert the toner cartridge into the printer by aligning the side rails of the cartridge with the arrows on the side rails inside the printer.

**Warning—Potential Damage:** Do not expose the imaging unit to direct light for more than 10 minutes. Extended exposure to light may cause print quality problems.

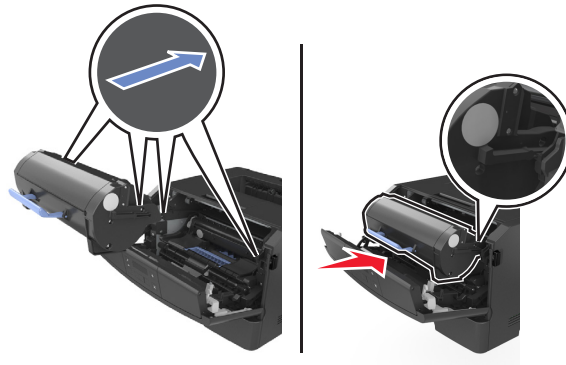

- 6 Close the front door.

## Replacing the imaging unit

- 1 Press the button on the right side of the printer, and then open the front door.

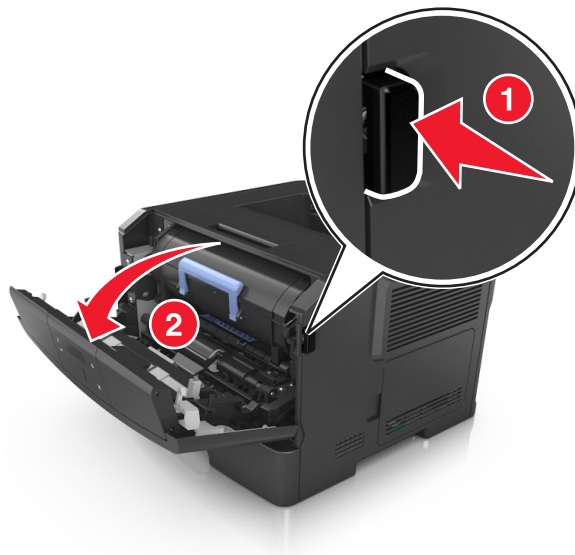

- 
- 2 Pull the toner cartridge out using the handle.



- 
- 
- 3 Lift the blue handle, and then pull the imaging unit out of the printer.

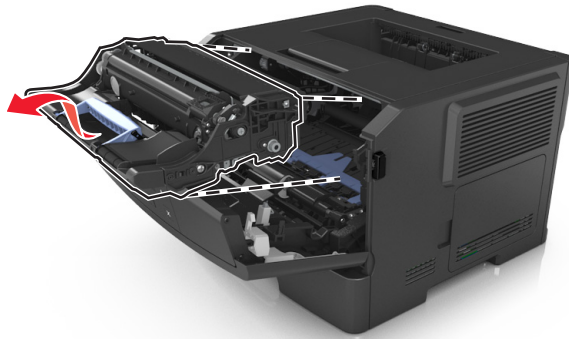

- 
- 
- 
- 4 Unpack the new imaging unit, and then shake it.

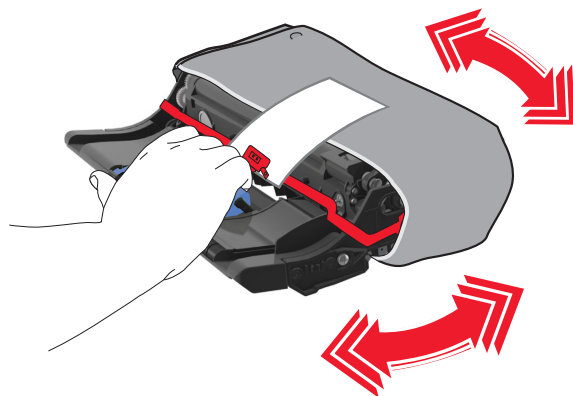

- 
- 
- 
- 
- 5 Remove all packing materials from the imaging unit.

**Warning—Potential Damage:** Do not expose the imaging unit to direct light for more than 10 minutes. Extended exposure to light may cause print quality problems.

**Warning—Potential Damage:** Do not touch the photoconductor drum. Doing so may affect the print quality of future print jobs.

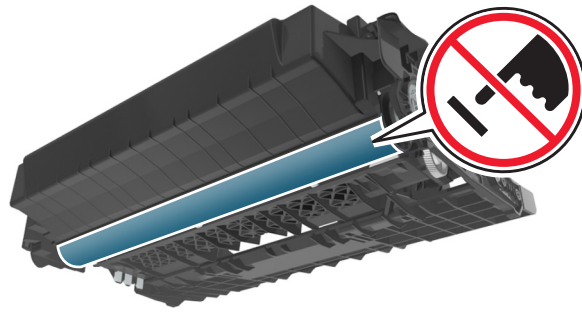

**6** Insert the imaging unit into the printer by aligning the arrows on the side rails of the imaging unit with the arrows on the side rails inside the printer.

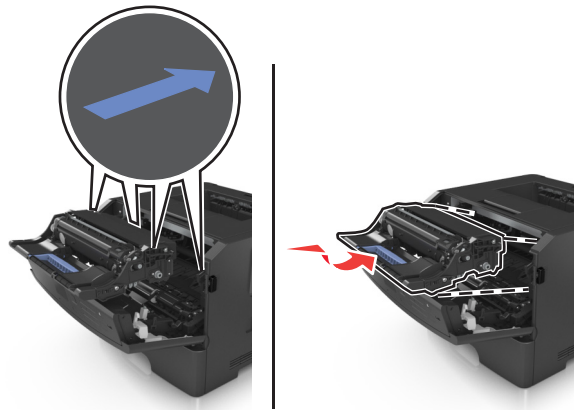

**7** Insert the toner cartridge into the printer by aligning the side rails of the cartridge with the arrows on the side rails inside the printer.

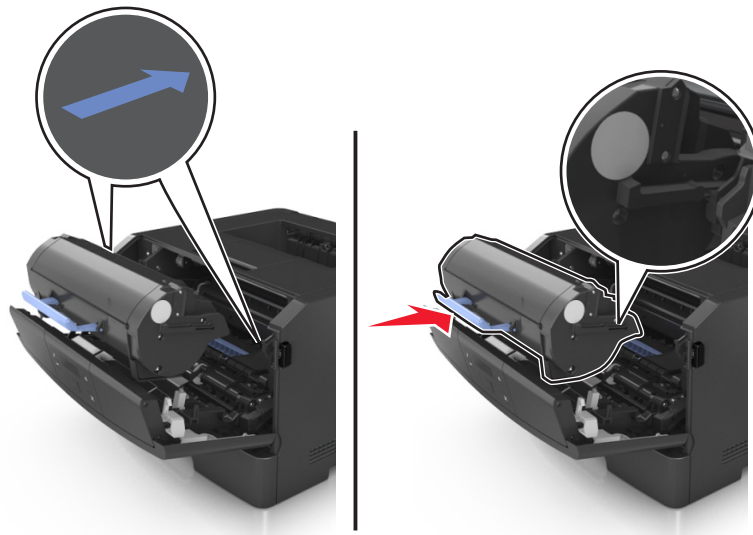

**8** Close the front door.

## Moving the printer

### Before moving the printer

**CAUTION—POTENTIAL INJURY:** Before moving the printer, follow these guidelines to avoid personal injury or printer damage:

- Turn the printer off using the power switch, and then unplug the power cord from the electrical outlet.
- Disconnect all cords and cables from the printer before moving it.
- If an optional tray is installed, then remove it from the printer. To remove the optional tray, slide the latch on the right side of the tray toward the front of the tray until it *clicks* into place.



- Use the handholds located on both sides of the printer to lift it.
- Make sure your fingers are not under the printer when you set it down.
- Before setting up the printer, make sure there is adequate clearance around it.

Use only the power cord provided with this product or the manufacturer's authorized replacement.

**Warning—Potential Damage:** Damage to the printer caused by improper moving is not covered by the printer warranty.

### Moving the printer to another location

The printer and its hardware options can be safely moved to another location by following these precautions:

- Any cart used to move the printer must have a surface able to support the full footprint of the printer.
- Any cart used to move the hardware options must have a surface able to support the dimensions of the hardware options.
- Keep the printer in an upright position.
- Avoid severe jarring movements.

### Shipping the printer

When shipping the printer, use the original packaging.

# Managing the printer

## Managing printer messages

Use the Status Messenger application to view error messages requiring your intervention on your printer. When there is an error, a bubble appears telling you what the error is, and points you to the appropriate recovery information.

If you installed Status Messenger with your printer software, then the application launches automatically when the software installation is completed. The installation is successful if you see the Status Messenger icon in the system tray.

### Notes:

- This feature is available only in Windows XP or later.
- Make sure bidirectional communication support is in place so the printer and the computer can communicate.

## Disabling Status Messenger

- 1 From the system tray, right-click the Status Messenger icon.
- 2 Select **Exit**.

## Enabling Status Messenger

- 1 Use the Search command on the Start menu to locate Status Messenger.
- 2 Open the application.

## Accessing Status Monitor Center

Use this application to view the status of any USB- or network-connected printer and to order supplies online.

**Note:** Make sure bidirectional communication support is in place so the printer and the computer can communicate.

- 1 Use the Search command on the Start menu to locate Status Monitor Center.
- 2 Open the application.

## Accessing the remote control panel

The remote control panel on your computer screen lets you interact with the printer control panel, even when you are not physically near the network printer. From your computer screen, you can view the printer status and do print-related tasks you might normally do while standing at the network printer.

- 1 Open a Web browser, and then type the printer IP address in the address field.

### Notes:

- Print a network setup page or menu settings page, and then locate the IP address in the TCP/IP section. The IP address appears as four sets of numbers separated by periods, such as 123.123.123.123.

- If you are using a proxy server, then temporarily disable it to load the Web page correctly.

**2** Press **Enter** to open the Web page of your printer.

**3** Click **Applications**.

**Note:** The remote control panel requires a Java plug-in to launch.

## Viewing reports

You can view some reports from the Embedded Web Server. These reports are useful for assessing the status of the printer, network, and supplies.

**1** Open a Web browser, and then type the printer IP address in the address field.

**Notes:**

- View the printer IP address in the TCP/IP section in the Network/Ports menu. The IP address appears as four sets of numbers separated by periods, such as 123.123.123.123.
- If you are using a proxy server, then temporarily disable it to load the Web page correctly.

**2** Click **Reports**, and then click the type of report you want to view.

## Configuring supply notifications from the Embedded Web Server

You can determine how you would like to be notified when supplies run nearly low, low, very low, or reach their end-of-life by setting the selectable alerts.

**Notes:**

- Selectable alerts can be set on the toner cartridge and imaging unit.
- All selectable alerts can be set for nearly low, low, and very low supply conditions. Not all selectable alerts can be set for the end-of-life supply condition. E-mail selectable alert is available for all supply conditions.
- The percentage of estimated remaining supply that prompts the alert can be set on some supplies for some supply conditions.

**1** Open a Web browser, and then type the printer IP address in the address field.

**Notes:**

- View the printer IP address in the TCP/IP section in the Network/Ports menu. The IP address appears as four sets of numbers separated by periods, such as 123.123.123.123.
- If you are using a proxy server, then temporarily disable it to load the Web page correctly.

**2** Click **Settings > Print Settings > Supply Notifications**.

**3** From the drop-down menu for each supply, select one of the following notification options:

Notification	Description
Off	The normal printer behavior for all supplies occurs.
E-mail Only	The printer generates an e-mail when the supply condition is reached. The status of the supply will appear on the menus page and status page.
Warning	The printer displays the warning message and generates an e-mail about the status of the supply. The printer does not stop when the supply condition is reached.
Continuable Stop <sup>1</sup>	The printer stops processing jobs when the supply condition is reached, and the user needs to press a button to continue printing.
Non Continuable Stop <sup>1,2</sup>	The printer stops when the supply condition is reached. The supply must be replaced to continue printing.
<sup>1</sup> The printer generates an e-mail about the status of the supply when supply notification is enabled. <sup>2</sup> The printer stops when some supplies become empty to prevent damage.	

4 Click **Submit**.

## Copying printer settings to other printers

**Note:** This feature is available only in network printers.

1 Open a Web browser, and then type the printer IP address in the address field.

**Notes:**

- View the printer IP address in the TCP/IP section in the Network/Ports menu. The IP address appears as four sets of numbers separated by periods, such as 123.123.123.123.
- If you are using a proxy server, then temporarily disable it to load the Web page correctly.

2 Click the **Copy Printer Settings**.

3 To change the language, select a language from the drop-down menu, and then click **Click here to submit language**.

4 Click **Printer Settings**.

5 Type the IP addresses of the source and target printers in their appropriate fields.

**Note:** If you want to add or remove a target printer, then click **Add Target IP** or **Remove Target IP**.

6 Click **Copy Printer Settings**.

## Restoring factory default settings

If you want to keep a list of the current menu settings for reference, then print a menu settings page before restoring the factory default settings. For more information, see [“Printing a menu settings page” on page 24](#).

If you want a more comprehensive method of restoring the printer factory default settings, then perform the Wipe All Settings option. For more information, see [“Erasing non-volatile memory” on page 85](#).

**Warning—Potential Damage:** Restoring factory defaults returns most printer settings to the original factory default settings. Exceptions include the display language, custom sizes and messages, and Network/Port menu settings. All downloads stored in the RAM are deleted.

From the printer control panel, navigate to:

 > Settings >  > General Settings >  > Factory Defaults >  > Restore Now > 

## Creating a printer control panel PIN

The Panel PIN Protect menu lets you restrict access to the menus from the printer control panel. To restrict access to the menus, create a Personal Identification Number (PIN), and then assign the PIN to each menu.

- 1 Open a Web browser, and then type the printer IP address in the address field.

**Notes:**

- View the printer IP address in the TCP/IP section in the Network/Ports menu. The IP address appears as four sets of numbers separated by periods, such as 123.123.123.123.
- If you are using a proxy server, then temporarily disable it to load the Web page correctly.

- 2 Click **Settings > Security > Panel PIN Protect**.

- 3 From the Create User PIN or Create Admin PIN sections, enter your PIN.

**Note:** You can enter up to 16 digits for your PIN.

- 4 Click **Modify**.

- 5 From any menu in the Administrative Menus, Management, or Function Access sections, select **User PIN Protected** or **Admin PIN Protected** or **Admin PIN and User PIN Protected**.

**Note:** Using an Admin PIN, you can still access a menu assigned with a User PIN.

- 6 Click **Submit**.

If you try to access a PIN-protected menu from the printer control panel, the printer will require you to enter the PIN.

**Note:** After you enter the last digit of the PIN, make sure to press  on the printer control panel for more than three seconds.



## Clearing jams

Carefully select paper and specialty media and load them properly to avoid most jams. If jams do occur, then follow the steps outlined in this chapter.

**Note:** Jam Recovery is set to Auto by default. The printer reprints jammed pages unless the memory required to hold the pages is needed for other printer tasks.

## Avoiding jams

### Load paper properly

- Make sure paper lies flat in the tray.

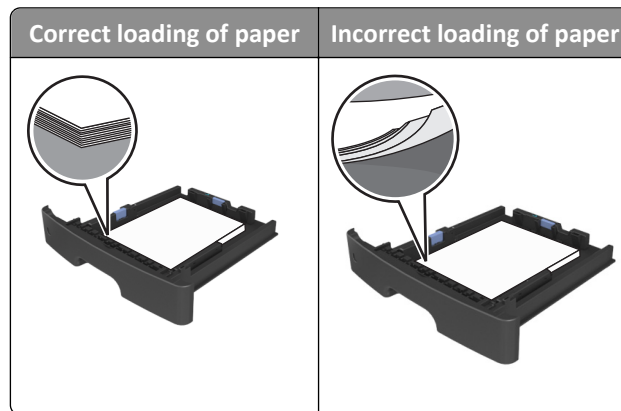

- Do not remove a tray while the printer is printing.
- Do not load a tray while the printer is printing. Load it before printing, or wait for a prompt to load it.
- Do not load too much paper. Make sure the stack height is below the maximum paper fill indicator.
- Do not slide the paper into the tray. Load paper as shown in the illustration.

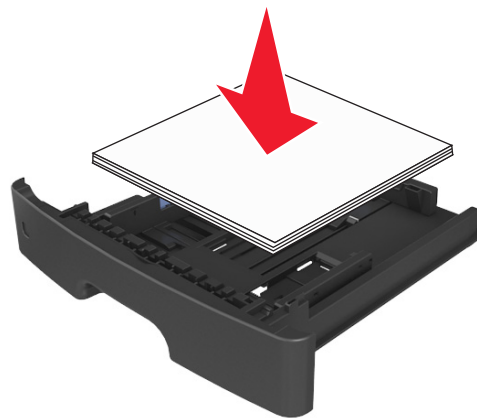

- Make sure the guides in the tray or the multipurpose feeder are properly positioned and are not pressing tightly against the paper or envelopes.
- Push the tray firmly into the printer after loading paper.

### Use recommended paper

- Use only recommended paper or specialty media.
- Do not load wrinkled, creased, damp, bent, or curled paper.
- Flex, fan, and straighten paper before loading it.

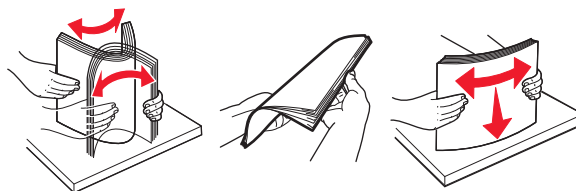

- Do not use paper that has been cut or trimmed by hand.
- Do not mix paper sizes, weights, or types in the same tray.
- Make sure the paper size and type are set correctly on the computer or printer control panel.
- Store paper according to manufacturer recommendations.

## Understanding jam messages and locations

When a jam occurs, a message indicating the jam location and information to clear the jam appears on the printer display. Open the doors, covers, and trays indicated on the display to remove the jam.

#### Notes:

- When Jam Assist is set to On, the printer automatically flushes blank pages or pages with partial prints to the standard bin after a jammed page has been cleared. Check your printed output stack for discarded pages.
- When Jam Recovery is set to On or Auto, the printer reprints jammed pages. However, the Auto setting does not guarantee that the page will print.



	Area	Printer control panel message	What to do
1	Standard bin	Jam, standard bin [20y.xx]	Remove the jammed paper.
2	Rear door	Jam, rear door [20y.xx]	Open the rear door, and then remove the jammed paper.

	Area	Printer control panel message	What to do
3	Tray 1	Jam, pull tray 1. Push down blue flap. [23y.xx]	Pull tray 1 completely out, then push the front duplex flap down, and then remove the jammed paper. <b>Note:</b> You may need to open the rear door to clear some 23y.xx paper jams.
4	Tray [x]	Jam, tray [x] [24y.xx]	Pull the indicated tray out, and then remove the jammed paper.
5	Multipurpose feeder	Jam, MP feeder. [250.xx]	Remove all paper from the multipurpose feeder, and then remove the jammed paper.
6	Front door	Jam, front door. [20y.xx]	Open the front door, and then remove the toner cartridge, imaging unit, and jammed paper.

## Jam, front door [20y.xx]

 **CAUTION—HOT SURFACE:** The inside of the printer might be hot. To reduce the risk of injury from a hot component, allow the surface to cool before touching it.

- 1 Press the button on the right side of the printer, and then open the front door.

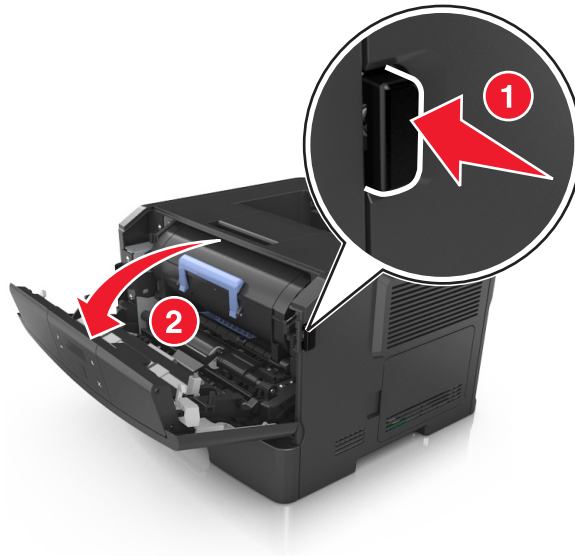

- 2 Pull the toner cartridge out using the handle.



- 3 Lift the blue handle, and then pull out the imaging unit from the printer.

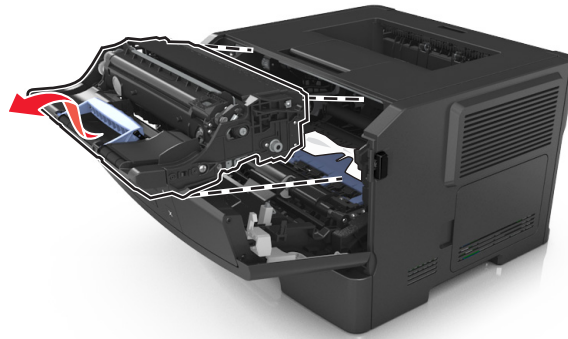

**Warning—Potential Damage:** Do not touch the photoconductor drum. Doing so may affect the print quality of future print jobs.

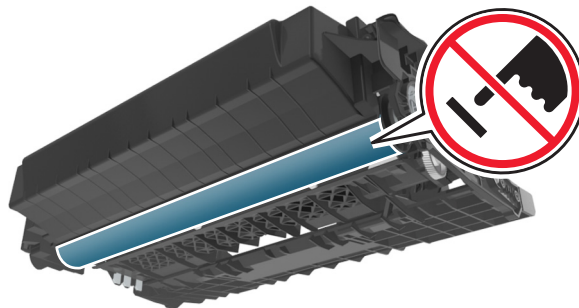

- 4 Place the imaging unit aside on a flat, smooth surface.

**Warning—Potential Damage:** Do not expose the imaging unit to direct light for more than 10 minutes. Extended exposure to light can cause print quality problems.

- 5 Lift the blue flap in front of the printer.

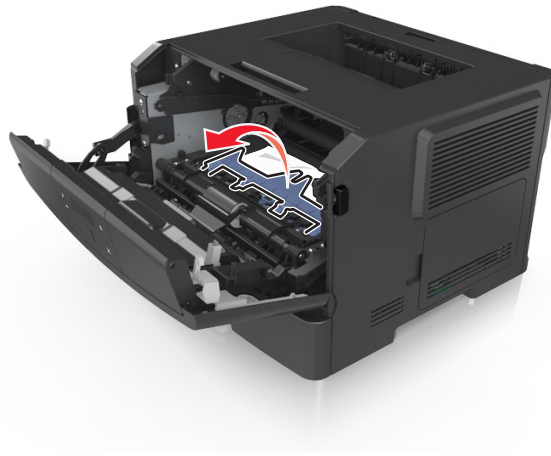

- 6 Firmly grasp the jammed paper on each side, and then gently pull it out.

**Note:** Make sure all paper fragments are removed.

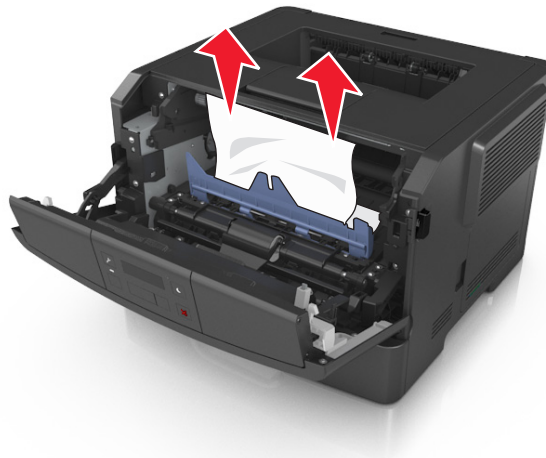

- 7 Insert the imaging unit by aligning the arrows on the side rails of the unit with the arrows on the side rails inside the printer, and then insert the imaging unit into the printer.

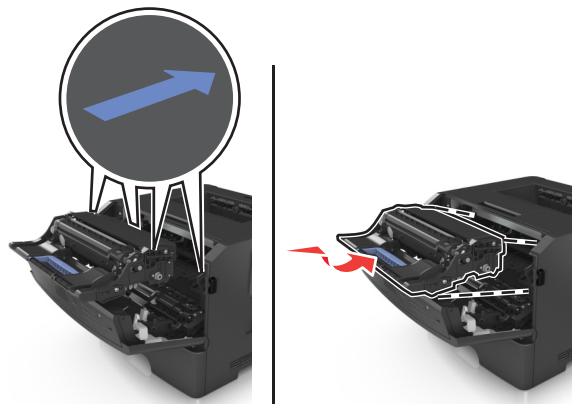

- 8 Insert the toner cartridge by aligning the side rails of the cartridge with the arrows on the side rails inside the printer, and then insert the cartridge into the printer.

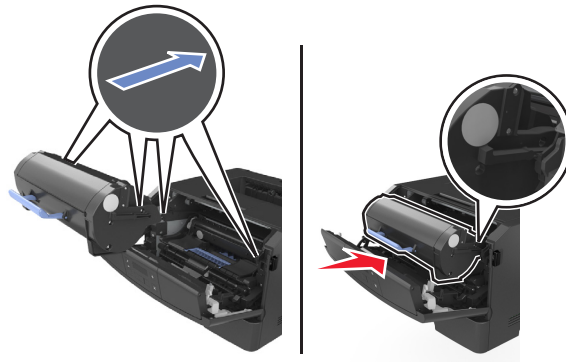

- 9 Close the front door.

- 10 From the printer control panel, press **OK** to clear the message and continue printing.

## Jam, rear door [20y.xx]

- 1 Press the button on the right side of the printer, and then open the front door.

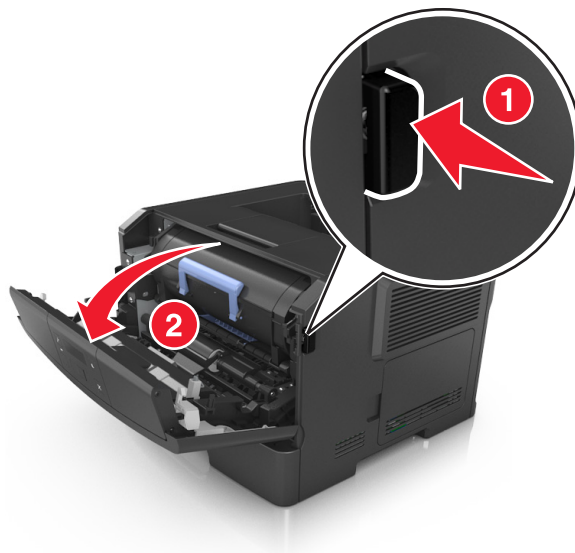

- 2 Gently pull down the rear door.

 **CAUTION—HOT SURFACE:** The inside of the printer might be hot. To reduce the risk of injury from a hot component, allow the surface to cool before touching it.



**3** Firmly grasp the jammed paper on each side, and then gently pull it out.

**Note:** Make sure all paper fragments are removed.

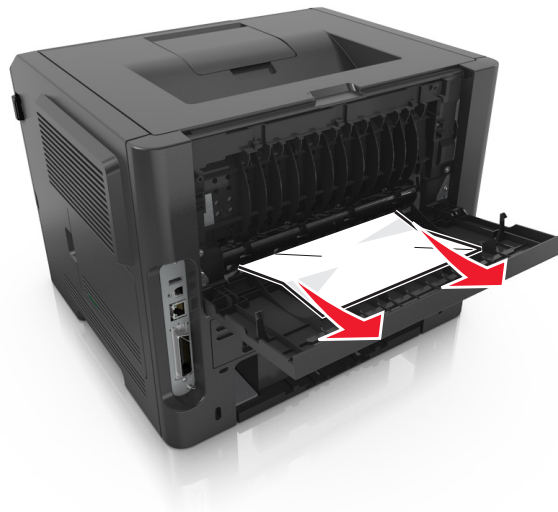

**4** Close the rear and front doors.

**5** From the printer control panel, press **OK** to clear the message and continue printing.

## Jam, standard bin [20y.xx]

**1** Firmly grasp the jammed paper on each side, and then gently pull it out.

**Note:** Make sure all paper fragments are removed.



2 From the printer control panel, press **OK** to clear the message and continue printing.

## Jam, pull tray 1. Push down blue flap. [23y.xx]

1 Pull out the tray completely.





- 2 Locate the blue lever, and then pull it down to release the jam.

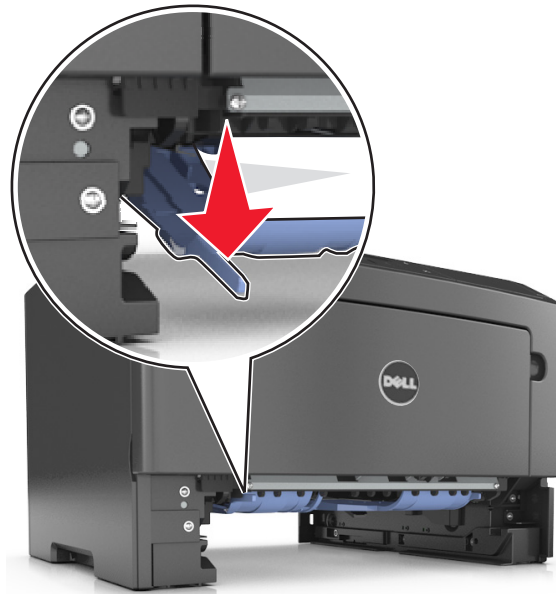

**Note:** If the jammed paper is not visible in the duplex area, then open the rear door, and then gently remove the jammed paper. Make sure all paper fragments are removed.

- 3 Firmly grasp the jammed paper on each side, and then gently pull it out.

**Note:** Make sure all paper fragments are removed.



- 4 Insert the tray.

- 5 From the printer control panel, press **OK** to clear the message and continue printing.

## Jam, tray [x] [24y.xx]

- 1 Pull out the tray completely.



- 2 Firmly grasp the jammed paper on each side, and then gently pull it out.

**Note:** Make sure all paper fragments are removed.

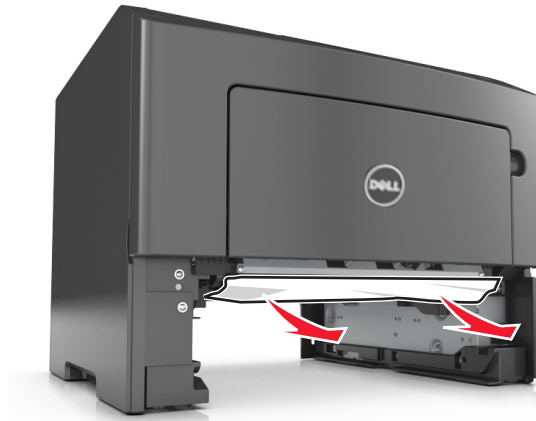

- 3 Insert the tray.

- 4 From the printer control panel, press **OK** to clear the message and continue printing.

## Jam, MP feeder [250.xx]

- 1 From the multipurpose feeder, firmly grasp the jammed paper on each side, and then gently pull it out.

**Note:** Make sure all paper fragments are removed.



- 2 Flex the sheets of paper back and forth to loosen them, and then fan them. Do not fold or crease the paper. Straighten the edges on a level surface.

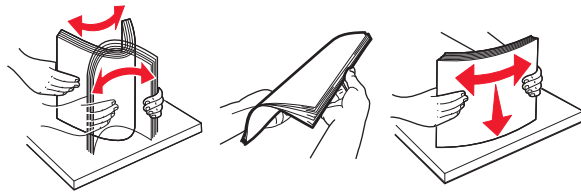

- 3 Reload paper into the multipurpose feeder.



**Note:** Make sure the paper guide lightly rests against the edge of the paper.

- 4 From the printer control panel, press **OK** to clear the message and continue printing.

# Troubleshooting

## Understanding the printer messages

### Bin full. Remove paper.

Remove the paper stack from the standard bin.

### Cannot collate large document [37]

Try one or more of the following:

- From the printer control panel, press **OK** to print the portion of the job already stored and begin collating the rest of the print job.
- Cancel the current print job.

### Cannot defrag flash memory [37]

Try one or more of the following:

- From the printer control panel, press **OK** to stop the defragmentation and continue printing.
- Delete fonts, macros, and other data in the printer memory. From the printer control panel, navigate to:  
**⚙** > **Settings** > **OK** > **Print Settings** > **OK** > **Utilities Menu** > **OK** > **Format Flash** > **OK** > **Yes** > **OK**
- Install additional printer memory.

### Cartridge low [88.xy]

You may need to order a toner cartridge. If necessary, press **OK** on the printer control panel to clear the message and continue printing.

### Cartridge nearly low [88.xy]

If necessary, press **OK** on the printer control panel to clear the message and continue printing.

### Cartridge very low, [x] estimated pages remain [88.xy]

You may need to replace a toner cartridge very soon. For more information, see the “Replacing supplies” section of the *User’s Guide*.

If necessary, press **OK** on the printer control panel to clear the message and continue printing.

## Change [paper source] to [custom type name]. Load [orientation].

Try one or more of the following:

- Load the correct size and type of paper in the tray, and then press **OK** on the printer control panel.  
**Note:** Make sure the paper size and type settings are specified in the Paper menu on the printer control panel.
- Cancel the print job.

## Change [paper source] to [custom string]. Load [orientation].

Try one or more of the following:

- Load the correct size and type of paper in the tray, and then press **OK** on the printer control panel.  
**Note:** Make sure the paper size and type settings are specified in the Paper menu on the printer control panel.
- Cancel the print job.

## Change [paper source] to [paper size]. Load [orientation].

Try one or more of the following:

- Load the correct size and type of paper in the tray, and then press **OK** on the printer control panel.  
**Note:** Make sure the paper size and type settings are specified in the Paper menu on the printer control panel.
- Cancel the print job.

## Change [paper source] to [paper type] [paper size]. Load [orientation].

Try one or more of the following:

- Load the correct size and type of paper in the tray, and then press **OK** on the printer control panel.  
**Note:** Make sure the paper size and type settings are specified in the Paper menu on the printer control panel.
- Cancel the print job.

## Close front door

Close the front door of the printer.

## Complex page may misprint [39]

Try one or more of the following:

- From the printer control panel, press **OK** to clear the message and continue printing.
- Reduce the number and size of fonts, the number and complexity of images, and the number of pages in the print job.
- Cancel the print job.
- Install additional printer memory.

## Flash memory full [52]

Try one or more of the following:

- From the printer control panel, press **OK** to clear the message and continue printing.
- Delete fonts, macros, and other data stored in the flash memory. From the printer control panel, navigate to:  
**⚙** > **Settings** > **OK** > **Print Settings** > **OK** > **Utilities Menu** > **OK** > **Format Flash** > **OK** > **Yes** > **OK**
- Use a larger-capacity flash memory card.

**Note:** Downloaded fonts and macros that are not stored in the flash memory are deleted when the printer is powered off or restarted.

## Flash memory unformatted [53]

Try one or more of the following:

- From the printer control panel, press **OK** to stop the defragmentation and continue printing.
- Format the flash memory device.

**Note:** If the error message remains, then the flash memory device may be defective and need to be replaced.

## Defective flash memory [51]

Try one or more of the following:

- Replace the defective flash memory card.
- From the printer control panel, press **OK** to ignore the message and continue printing.
- Cancel the current print job.

## Imaging unit low [84.xy]

You may need to order an imaging unit. If necessary, press **OK** on the printer control panel to clear the message and continue printing.

## Imaging unit nearly low [84.xy]

If necessary, press **OK** on the printer control panel to clear the message and continue printing.

## Imaging unit very low, [x] estimated pages remain [84.xy]

You may need to replace the imaging unit very soon. For more information, see the “Replacing supplies” section of the *User’s Guide*.

If necessary, press **OK** on the printer control panel to clear the message and continue printing.

## Insert tray [x]

Insert the indicated tray into the printer.

## Load [paper source] with [custom type name] [orientation]

Try one or more of the following:

- Load the tray or feeder with the correct size and type of paper.
- From the printer control panel, press  to clear the message and continue printing.

**Note:** If the printer finds a tray that has the correct size and type of paper, then it feeds from that tray. If the printer cannot find a tray that has the correct size and type of paper, then it prints from the default paper source.

- Cancel the current job.

## Load [paper source] with [custom string] [orientation]

Try one or more of the following:

- Load the indicated tray or feeder with the correct size and type of paper.
- From the printer control panel, press  to clear the message and continue printing.

**Note:** If the printer finds a tray that has the correct paper type and size, then it feeds from that tray. If the printer cannot find a tray that has the correct size and type of paper, then it prints from the default paper source.

- Cancel the current job.

## Load [paper source] with [paper size] [orientation]

Try one or more of the following:

- Load the tray or feeder with the correct size of paper.
- From the printer control panel, press  to clear the message and continue printing.

**Note:** If the printer finds a tray that has the correct paper size, then it feeds from that tray. If the printer cannot find a tray that has the correct size of paper, then it prints from the default paper source.

- Cancel the current job.

## Load [paper source] with [paper type] [paper size] [orientation]

Try one or more of the following:

- Load the tray or feeder with the correct size and type of paper.
- From the printer control panel, press  to clear the message and continue printing.

**Note:** If the printer finds a tray that has the correct size and type of paper, then it feeds from that tray. If the printer cannot find a tray that has the correct size and type of paper, then it prints from the default paper source.

- Cancel the current job.

## Load MP feeder with [custom type name] [orientation]

Try one or more of the following:

- Load the feeder with the correct size and type of paper.
- From the printer control panel, press  to clear the message and continue printing.

**Note:** If no paper is loaded in the feeder, then the printer manually overrides the request, and then prints from an automatically selected tray.

- Cancel the current job.

## Load MP feeder with [custom string] [orientation]

Try one or more of the following:

- Load the feeder with the correct size and type of paper.
- From the printer control panel, press  to clear the message and continue printing.

**Note:** If no paper is loaded in the feeder, then the printer manually overrides the request, and then prints from an automatically selected tray.

- Cancel the current job.

## Load MP feeder with [paper size] [orientation]

Try one or more of the following:

- Load the feeder with the correct size of paper.
- From the printer control panel, press  to clear the message and continue printing.

**Note:** If no paper is loaded in the feeder, then the printer manually overrides the request, and then prints from an automatically selected tray.

- Cancel the current job.

## Load MP feeder with [paper type] [paper size] [orientation]

Try one or more of the following:

- Load the feeder with the correct size and type of paper.
- From the printer control panel, press  to clear the message and continue printing.

**Note:** If no paper is loaded in the feeder, then the printer manually overrides the request, and then prints from an automatically selected tray.

- Cancel the current job.



## Memory full [38]

Try one or more of the following:

- From the printer control panel, press **OK** to clear the message.
- Decrease the resolution setting.
- Install additional printer memory.

## Memory low, no Resource Save [35]

Try one or more of the following:

- From the printer control panel, press **OK** to disable Resource Save, clear the message, and continue printing.
- Install additional printer memory.

## Network error, port [x] [54]

Try one or more of the following:

- From the printer control panel, press **OK** to clear the message and continue printing.
- Unplug the router, wait for 30 seconds, and then plug it back again.
- Turn off the printer, wait for about 10 seconds, and then turn the printer back on.
- Update the network firmware in the printer or the print server. For more information, contact technical support.

## Network error, standard port [54]

Try one or more of the following:

- From the printer control panel, press **OK** to clear the message and continue printing.
- Unplug the router, wait for 30 seconds, and then plug it back again.
- Turn off the printer, wait for about 10 seconds, and then turn the printer back on.
- Update the network firmware in the printer or the print server. For more information, contact technical support.

## Non-Dell [supply type], see User's Guide [33.xy]



**Note:** The supply type can either be a toner cartridge or imaging unit.

The printer has detected a non-Dell supply or part installed in the printer.

Your Dell printer is designed to function best with genuine Dell supplies and parts. Use of third-party supplies or parts may affect the performance, reliability, or life of the printer and its imaging components.

All life indicators are designed to function with Dell supplies and parts, and may deliver unpredictable results if third-party supplies or parts are used. Imaging component usage beyond the intended life may damage your Dell printer or associated components.

**Warning—Potential Damage:** Use of third-party supplies or parts can affect warranty coverage. Damage caused by the use of third-party supplies or parts are not covered by the warranty.

To accept any and all of these risks and to proceed with the use of non-genuine supplies or parts in your printer, press  and  on the printer control panel simultaneously for 15 seconds to clear the message and continue printing.

If you do not wish to accept these risks, then remove the third-party supply or part from your printer, and then install a genuine Dell supply or part.

**Note:** For the list of supported supplies, see the “Ordering supplies” section of the *User's Guide* or visit [www.dell.com/printers](http://www.dell.com/printers).

## Paper too short [34]

Try one or more of the following:

- Load the correct size of paper in the tray.
- From the printer control panel, press  to clear the message and print using a different tray.
- Check the tray length and width guides and make sure the paper is loaded properly in the tray.
- Make sure the correct paper size and type are specified in Print Properties or in the Print dialog.
- Make sure the paper size and type settings are specified in the Paper menu on the printer control panel.
- Make sure the paper size is correctly set. For example, if the MP Feeder Size is set to Universal, then make sure the paper is large enough for the data being printed.
- Cancel the print job.

## Parallel port disabled [56]

Try one or more of the following:

- From the printer control panel, press  to clear the message and continue printing.  
**Note:** The printer discards any data received through the parallel port.
- From the printer control panel, set Parallel Buffer to Auto.

## Printer restart. Check last job.

Press  on the printer control panel to clear the message and continue printing.

For more information, visit [www.dell.com/support/printers](http://www.dell.com/support/printers) or contact technical support.

## Rear USB port disabled [56]

Try one or more of the following:

- From the printer control panel, press  to clear the message and continue printing.  
**Note:** The printer discards any data received through the USB port.
- From the printer control panel, set USB Buffer to Auto.

## Replace cartridge, 0 estimated pages remain [88.xy]

Replace the toner cartridge to clear the message and continue printing. For more information, see the instruction sheet that came with the supply or see the “Replacing supplies” section of the *User’s Guide*.

**Note:** If you do not have a replacement cartridge, then visit our Web site or contact the place where you purchased the printer.

## Replace cartridge, printer region mismatch [42.xy]

Install a suitable toner cartridge.

## Replace imaging unit, 0 estimated pages remain [84.xy]

Replace the imaging unit to clear the message and continue printing. For more information, see the instruction sheet that came with the supply or see the “Replacing supplies” section of the *User’s Guide*.

**Note:** If you do not have a replacement imaging unit, then visit our Web site or contact the place where you purchased the printer.

## Reinstall missing or unresponsive cartridge [31.xy]

Try one or more of the following:

- Check if the toner cartridge is missing. If missing, install the toner cartridge.  
For information on installing the cartridge, see the “Replacing supplies” section of the *User’s Guide*.
- If the toner cartridge is installed, then remove the unresponsive toner cartridge, and then reinstall it.

**Note:** If the message appears after reinstalling the supply, then the cartridge is defective. Replace the toner cartridge.

## Reinstall missing or unresponsive imaging unit [31.xy]

Try one or more of the following:

- Check if the imaging unit is missing. If missing, install the imaging unit.  
For information on installing the imaging unit, see the “Replacing supplies” section of the *User’s Guide*.
- If the imaging unit is installed, then remove the unresponsive imaging unit, and then reinstall it.

**Note:** If the message appears after reinstalling the supply, then the imaging unit is defective. Replace the imaging unit.

## Replace unsupported cartridge [32.xy]

Remove the toner cartridge, and then install a supported one to clear the message and continue printing. For more information, see the instruction sheet that came with the supply or see the “Replacing supplies” section of the *User’s Guide*.

**Note:** If you do not have a replacement cartridge, then see the “Ordering supplies” section of the *User’s Guide* or visit our Web site.

## Replace unsupported imaging unit [32.xy]

Remove the imaging unit, and then install a supported one to clear the message and continue printing. For more information, see the instruction sheet that came with the supply or see the “Replacing supplies” section of the *User’s Guide*.

**Note:** If you do not have a replacement imaging unit, then see the “Ordering supplies” section of the *User’s Guide* or visit our Web site.

## Too many trays. Remove some. [58]

- 1 Turn off the printer.
- 2 Unplug the power cord from the electrical outlet.
- 3 Remove the extra trays.
- 4 Connect the power cord to the electrical outlet.
- 5 Turn the printer back on.

## Solving printer problems

- “Basic printer problems” on page 116
- “Option problems” on page 118
- “Paper feed problems” on page 120

### Basic printer problems

#### The printer is not responding

Action	Yes	No
<p><b>Step 1</b> Make sure the printer is turned on.</p> <p>Is the printer turned on?</p>	Go to step 2.	Turn on the printer.
<p><b>Step 2</b> Check if the printer is in Sleep mode or Hibernate mode.</p> <p>Is the printer in Sleep mode or Hibernate mode?</p>	Press the Sleep button to wake the printer from Sleep mode or Hibernate mode.	Go to step 3.
<p><b>Step 3</b> Check if one end of the power cord is plugged into the printer and the other to a properly grounded electrical outlet.</p> <p>Is the power cord plugged into the printer and a properly grounded electrical outlet?</p>	Go to step 4.	Plug one end of the power cord into the printer and the other to a properly grounded electrical outlet.

Action	Yes	No
<p><b>Step 4</b> Check other electrical equipment plugged into the electrical outlet.</p> <p>Does other electrical equipment work?</p>	Unplug the other electrical equipment, and then turn on the printer. If the printer does not work, then reconnect the other electrical equipment.	Go to step 5.
<p><b>Step 5</b> Check if the cables connecting the printer and the computer are inserted in the correct ports.</p> <p>Are the cables inserted in the correct ports?</p>	Go to step 6.	<p>Make sure to match the following:</p> <ul style="list-style-type: none"> <li>• The USB symbol on the cable with the USB symbol on the printer</li> <li>• The appropriate Ethernet cable with the Ethernet port</li> </ul>
<p><b>Step 6</b> Make sure the electrical outlet is not turned off by a switch or breaker.</p> <p>Is the electrical outlet turned off by a switch or breaker?</p>	Turn on the switch or reset the breaker.	Go to step 7.
<p><b>Step 7</b> Check if the printer is plugged into any surge protectors, uninterruptible power supplies, or extension cords.</p> <p>Is the printer plugged into any surge protectors, uninterruptible power supplies, or extension cords?</p>	Connect the printer power cord directly to a properly grounded electrical outlet.	Go to step 8.
<p><b>Step 8</b> Check if one end of the printer cable is plugged into a port on the printer and the other to the computer, print server, option, or other network device.</p> <p>Is the printer cable securely attached to the printer and the computer, print server, option, or other network device?</p>	Go to step 9.	Connect the printer cable securely to the printer and the computer, print server, option, or other network device.
<p><b>Step 9</b> Make sure to install all hardware options properly and remove any packing material.</p> <p>Are all hardware options properly installed and all packing material removed?</p>	Go to step 10.	Turn off the printer, remove all packing materials, then reinstall the hardware options, and then turn on the printer.
<p><b>Step 10</b> Check if you have selected the correct port settings in the printer driver.</p> <p>Are the port settings correct?</p>	Go to step 11.	Use correct printer driver settings.

Action	Yes	No
<p><b>Step 11</b> Check the installed printer driver.</p> <p>Is the correct printer driver installed?</p>	Go to step 12.	Install the correct printer driver.
<p><b>Step 12</b> Turn off the printer, then wait for about 10 seconds, and then turn the printer back on.</p> <p>Is the printer working?</p>	The problem is solved.	Contact <a href="#">technical support</a> .

### Printer display is blank

Action	Yes	No
<p><b>Step 1</b> Press the Sleep button on the printer control panel.</p> <p>Does <b>Ready</b> appear on the printer display?</p>	The problem is solved.	Go to step 2.
<p><b>Step 2</b> Turn off the printer, then wait for about 10 seconds, and then turn the printer back on.</p> <p>Do <b>Please wait</b> and <b>Ready</b> appear on the printer display?</p>	The problem is solved.	Turn off the printer, and then contact <a href="#">technical support</a> .

### Option problems

#### Cannot detect internal option

Action	Yes	No
<p><b>Step 1</b> Turn off the printer, then wait for about 10 seconds, and then turn on the printer.</p> <p>Does the internal option operate correctly?</p>	The problem is solved.	Go to step 2.
<p><b>Step 2</b> Check if the internal option is properly installed in the controller board.</p> <ul style="list-style-type: none"> <li><b>a</b> Turn off the printer using the power switch, and then unplug the power cord from the electrical outlet.</li> <li><b>b</b> Make sure the internal option is installed in the appropriate connector in the controller board.</li> <li><b>c</b> Connect the power cord to the printer, then to a properly grounded electrical outlet, and then turn on the printer.</li> </ul> <p>Is the internal option properly installed in the controller board?</p>	Go to step 3.	Connect the internal option to the controller board.

Action	Yes	No
<p><b>Step 3</b> Print a menu settings page, and then check to see if the internal option is listed in the Installed Features list.</p> <p>Is the internal option listed in the menu settings page?</p>	Go to step 4.	Reinstall the internal option.
<p><b>Step 4</b></p> <p><b>a</b> Check if the internal option is selected. It may be necessary to manually add the internal option in the printer driver to make it available for print jobs. For more information, see <a href="#">“Adding available options in the print driver” on page 20.</a></p> <p><b>b</b> Resend the print job.</p> <p>Does the internal option operate correctly?</p>	The problem is solved.	Contact <a href="#">technical support</a> .

### Tray problems

Action	Yes	No
<p><b>Step 1</b></p> <p><b>a</b> Open the tray and do one or more of the following:</p> <ul style="list-style-type: none"> <li>• Check for paper jams or misfeeds.</li> <li>• Check if the paper size indicators on the paper guides are aligned with the paper size indicators on the tray.</li> <li>• If you are printing on custom-size paper, then make sure that the paper guides rest against the edges of the paper.</li> <li>• Make sure the paper is below the maximum paper fill indicator.</li> <li>• Make sure paper lies flat in the tray.</li> </ul> <p><b>b</b> Check if the tray closes properly.</p> <p>Is the tray working?</p>	The problem is solved.	Go to step 2.
<p><b>Step 2</b></p> <p><b>a</b> Turn off the printer, then wait about 10 seconds, and then turn the printer back on.</p> <p><b>b</b> Resend the print job.</p> <p>Is the tray working?</p>	The problem is solved.	Go to step 3.
<p><b>Step 3</b></p> <p>Check if the tray is installed and recognized by the printer. Print a menu settings page, and then check if the tray is listed in the Installed Features list.</p> <p>Is the tray listed in the menu settings page?</p>	Go to step 4.	Reinstall the tray. For more information, see the setup documentation that came with the tray.

Action	Yes	No
<p><b>Step 4</b> Check if the tray is available in the printer driver.</p> <p><b>Note:</b> If necessary, manually add the tray in the printer driver to make it available for print jobs. For more information, see <a href="#">“Adding available options in the print driver” on page 20.</a></p> <p>Is the tray available in the printer driver?</p>	Go to step 5.	Manually add the tray in the printer driver.
<p><b>Step 5</b> Check if the option is selected.</p> <p><b>a</b> From the application you are using, select the option. For Mac OS X version 9 users, make sure the printer is set up in Chooser.</p> <p><b>b</b> Resend the print job.</p> <p>Is the tray working?</p>	The problem is solved.	Contact <a href="#">technical support</a> .

## Paper feed problems

### Paper frequently jams

Action	Yes	No
<p><b>Step 1</b></p> <p><b>a</b> Pull out the tray, and then do one or more of the following:</p> <ul style="list-style-type: none"> <li>• Make sure paper lies flat in the tray.</li> <li>• Check if the paper size indicators on the paper guides are aligned with the paper size indicators on the tray.</li> <li>• Check if the paper guides are aligned against the edges of the paper.</li> <li>• Make sure the paper is below the maximum paper fill indicator.</li> <li>• Check if you are printing on a recommended paper size and type.</li> </ul> <p><b>b</b> Insert the tray properly.</p> <p>If jam recovery is enabled, then the print jobs will reprint automatically.</p> <p>Do paper jams still occur frequently?</p>	Go to step 2.	The problem is solved.
<p><b>Step 2</b></p> <p><b>a</b> Load paper from a fresh package.</p> <p><b>Note:</b> Paper absorbs moisture due to high humidity. Store paper in its original wrapper until you use it.</p> <p><b>b</b> Resend the print job.</p> <p>Do paper jams still occur frequently?</p>	Go to step 3.	The problem is solved.









Action	Yes	No
<p><b>Step 3</b></p> <p><b>a</b> Review the tips on avoiding jams. For more information, see <a href="#">“Avoiding jams” on page 97</a>.</p> <p><b>b</b> Follow the recommendations, and then resend the print job.</p> <p>Do paper jams still occur frequently?</p>	<p>Contact <a href="#">technical support</a>.</p>	<p>The problem is solved.</p>

### Paper jam message remains after jam is cleared

Action	Yes	No
<p>Open front door and remove all trays.</p> <p><b>a</b> Clear any jammed pages.</p> <p><b>Note:</b> Make sure all paper fragments are removed.</p> <p><b>b</b> Press  to clear the message and continue printing.</p> <p>Does the paper jam message remain?</p>	<p>Contact <a href="#">technical support</a>.</p>	<p>The problem is solved.</p>

### Jammed pages are not reprinted

Action	Yes	No
<p><b>a</b> Turn on jam recovery.</p> <p><b>1</b> From the printer control panel, navigate to:</p> <p> &gt; <b>Settings</b> &gt;  &gt; <b>General Settings</b> &gt;  &gt; <b>Print Recovery</b> &gt;  &gt; <b>Jam Recovery</b> &gt; </p> <p><b>2</b> Press the arrow buttons until <b>On</b> or <b>Auto</b> appears, and then press .</p> <p><b>b</b> Resend the pages that did not print.</p> <p>Were the jammed pages reprinted?</p>	<p>The problem is solved.</p>	<p>Contact <a href="#">technical support</a>.</p>

# Solving print problems

## Printing problems

### Print jobs do not print

Action	Yes	No
<p><b>Step 1</b></p> <p><b>a</b> From the document you are trying to print, open the Print dialog and check if you have selected the correct printer.</p> <p><b>Note:</b> If the printer is not the default printer, then you must select the printer for each document that you want to print.</p> <p><b>b</b> Resend the print job.</p> <p>Do the jobs print?</p>	The problem is solved.	Go to step 2.
<p><b>Step 2</b></p> <p><b>a</b> Check if the printer is plugged in and turned on, and if <b>Ready</b> appears on the printer display.</p> <p><b>b</b> Resend the print job.</p> <p>Do the jobs print?</p>	The problem is solved.	Go to step 3.
<p><b>Step 3</b></p> <p>If an error message appears on the printer display, then clear the message.</p> <p><b>Note:</b> The printer continues to print after clearing the message.</p> <p>Do the jobs print?</p>	The problem is solved.	Go to step 4.
<p><b>Step 4</b></p> <p><b>a</b> Check if the ports (USB, serial, or Ethernet) are working and if the cables are securely connected to the computer and the printer.</p> <p><b>Note:</b> For more information, see the setup documentation that came with the printer.</p> <p><b>b</b> Resend the print job.</p> <p>Do the jobs print?</p>	The problem is solved.	Go to step 5.
<p><b>Step 5</b></p> <p><b>a</b> Turn off the printer, then wait for about 10 seconds, and then turn the printer back on.</p> <p><b>b</b> Resend the print job.</p> <p>Do the jobs print?</p>	The problem is solved.	Go to step 6.

Action	Yes	No
<p><b>Step 6</b></p> <p><b>a</b> Remove, and then reinstall the printer software. For more information, see <a href="#">“Installing the printer” on page 19</a>.</p> <p><b>Note:</b> For more information, visit <a href="http://www.dell.com/support/printers">www.dell.com/support/printers</a>.</p> <p><b>b</b> Resend the print job.</p> <p>Do the jobs print?</p>	The problem is solved.	Contact <a href="#">technical support</a> .







## Printing slows down





### Notes:

- When printing using narrow paper, the printer prints at a reduced speed to prevent damage to the fuser.
- The printer speed may be reduced when printing for long periods of time, or printing at elevated temperatures.
- The printer speed may also be reduced when the printed output resolution is set to 1,200 dpi.

Action	Yes	No
<p>Place letter- or A4-size paper in the tray, and then resend the print job.</p> <p>Does the print speed increase?</p>	The problem is solved.	Contact <a href="#">technical support</a> .

## Print job takes longer than expected

Action	Yes	No
<p><b>Step 1</b></p> <p>Reduce the number and size of fonts, the number and complexity of images, and the number of pages in the print job, and then resend the print job.</p> <p>Does the print job still take long?</p>	Go to step 2.	The problem is solved.
<p><b>Step 2</b></p> <p>Disable the Page Protect feature.</p> <p>From the printer control panel, navigate to:</p> <p> &gt; Settings &gt;  &gt; General Settings &gt;  &gt; Print Recovery &gt;  &gt; Page Protect &gt;  &gt; Off &gt; </p> <p>Does the print job still take long?</p>	Go to step 3.	The problem is solved.

Action	Yes	No
<p><b>Step 3</b>                      Change the environmental settings.                      From the printer control panel, navigate to:   &gt; Settings &gt;  &gt; General Settings &gt;  &gt; Eco-Mode &gt; select a setting &gt; </p> <p><b>Note:</b> When using the Eco-Mode setting, you may notice a reduction in performance.</p> <p>Does the print job still take long?</p>	<p>Install additional printer memory.                      For more information, contact <a href="#">technical support</a>.</p>	<p>The problem is solved.</p>

### Job prints from the wrong tray or on the wrong paper

Action	Yes	No
<p><b>Step 1</b>                      a Check if you are printing on paper that is supported by the tray.                      b Resend the print job.</p> <p>Did the job print from the correct tray or on the correct paper?</p>	<p>The problem is solved.</p>	<p>Go to step 2.</p>
<p><b>Step 2</b>                      a From the Paper menu on the printer control panel, set the paper size and type to match the paper loaded in the tray.                      b Resend the print job.</p> <p>Did the job print from the correct tray or on the correct paper?</p>	<p>The problem is solved.</p>	<p>Go to step 3.</p>
<p><b>Step 3</b>                      a Depending on your operating system, open Printing Preferences or the Print dialog, and then specify the paper type.                      b Resend the print job.</p> <p>Did the job print from the correct tray or on the correct paper?</p>	<p>The problem is solved.</p>	<p>Go to step 4.</p>
<p><b>Step 4</b>                      a Check if the trays are not linked.                      b Resend the print job.</p> <p>Did the job print from the correct tray or on the correct paper?</p>	<p>The problem is solved.</p>	<p>Contact <a href="#">technical support</a>.</p>

### Incorrect characters print

Action	Yes	No
<p><b>Step 1</b> Make sure the printer is not in Hex Trace mode.</p> <p><b>Note:</b> If <b>Ready Hex</b> appears on the printer display, then turn off the printer, and then turn it back on to deactivate Hex Trace mode.</p> <p>Is the printer in Hex Trace mode?</p>	Deactivate Hex Trace mode.	Go to step 2.
<p><b>Step 2</b></p> <p><b>a</b> From the printer control panel, select <b>Standard Network</b> or <b>Network [x]</b>, and then set SmartSwitch to On.</p> <p><b>b</b> Resend the print job.</p> <p>Do incorrect characters print?</p>	Contact <a href="#">technical support</a> .	The problem is solved.

### Tray linking does not work

**Note:** The trays and the multipurpose feeder do not automatically detect the paper size. You must set the size from the Paper Size/Type menu.

Action	Yes	No
<p><b>a</b> From the printer control panel, set the paper size and type in the Paper menu to match the paper loaded in the trays to be linked.</p> <p><b>Note:</b> The paper size and type must match for trays to be linked.</p> <p><b>b</b> Resend the print job.</p> <p>Do the trays link correctly?</p>	The problem is solved.	Contact <a href="#">technical support</a> .

### Large jobs do not collate

Action	Yes	No
<p><b>Step 1</b></p> <p><b>a</b> From the Finishing menu on the printer control panel, set Collate to (1,2,3) (1,2,3).</p> <p><b>b</b> Resend the print job.</p> <p>Did the job print and collate correctly?</p>	The problem is solved.	Go to step 2.
<p><b>Step 2</b></p> <p><b>a</b> From the printer software, set Collate to (1,2,3) (1,2,3).</p> <p><b>Note:</b> Setting Collate to (1,1,1) (2,2,2) in the software overrides the setting in the Finishing menu.</p> <p><b>b</b> Resend the print job.</p> <p>Did the job print and collate correctly?</p>	The problem is solved.	Go to step 3.

Action	Yes	No
<p><b>Step 3</b> Reduce the complexity of the print job by eliminating the number and size of fonts, the number and complexity of images, and the number of pages in the job.</p> <p>Did the job print and collate correctly?</p>	The problem is solved.	Contact <a href="#">technical support</a> .





### Unexpected page breaks occur

Action	Yes	No
<p><b>Step 1</b> Adjust the print timeout settings.</p> <ul style="list-style-type: none"> <li>a From the printer control panel, navigate to: <b>Settings &gt; General Settings &gt; Timeouts &gt; Print Timeout</b></li> <li>b Select a higher setting and then, depending on your printer model, select <b>OK</b> or <b>Submit</b>.</li> <li>c Resend the print job.</li> </ul> <p>Did the file print correctly?</p>	The problem is solved.	Go to step 2.
<p><b>Step 2</b> a Check the original file for manual page breaks. b Resend the print job.</p> <p>Did the file print correctly?</p>	The problem is solved.	Contact <a href="#">technical support</a> .

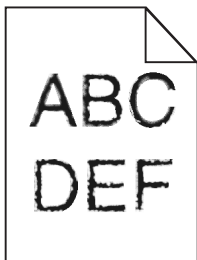
### Print quality problems

#### Characters have jagged or uneven edges



Action	Yes	No
<p><b>Step 1</b></p> <p><b>a</b> Print a font sample list to check if the fonts you are using are supported by the printer.</p> <p><b>1</b> From the printer control panel, navigate to:</p> <p> &gt; <b>Reports</b> &gt;  &gt; <b>Print Fonts</b> &gt; </p> <p><b>2</b> Press the arrow buttons until <b>PCL Fonts</b> or <b>PostScript Fonts</b> appears, and then press .</p> <p><b>b</b> Use a font that is supported by the printer or install the font that you want to use. For more information, contact your system support person.</p> <p><b>c</b> Resend the print job.</p> <p>Do prints still contain characters that have jagged or uneven edges?</p>	<p>Go to step 2.</p>	<p>The problem is solved.</p>
<p><b>Step 2</b></p> <p><b>a</b> Use a font that is supported by the printer or install the font that you want to use on your computer. For more information, contact your system support person.</p> <p><b>b</b> Resend the print job.</p> <p>Do prints still contain characters that have jagged or uneven edges?</p>	<p>Contact <a href="#">technical support</a>.</p>	<p>The problem is solved.</p>

**Printer is printing blank pages**

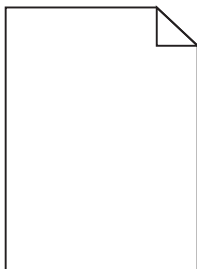

Action	Yes	No
<p><b>Step 1</b></p> <p><b>a</b> Check if there is packing material left on the imaging unit.</p> <ol style="list-style-type: none"> <li><b>1</b> Remove the toner cartridge, and then the imaging unit.</li> <li><b>2</b> Check if the packing material is properly removed from the imaging unit.</li> </ol> <p><b>Warning—Potential Damage:</b> Do not expose the imaging unit to direct light for more than 10 minutes. Extended exposure to light may cause print quality problems.</p> <ol style="list-style-type: none"> <li><b>3</b> Reinstall the imaging unit, and then the cartridge.</li> </ol> <p><b>b</b> Resend the print job.</p> <p>Is the printer still printing blank pages?</p>	Go to step 2.	The problem is solved.
<p><b>Step 2</b></p> <p><b>a</b> Redistribute the toner in the imaging unit.</p> <ol style="list-style-type: none"> <li><b>1</b> Remove the toner cartridge, and then the imaging unit.</li> <li><b>2</b> Firmly shake the imaging unit.</li> </ol> <p><b>Warning—Potential Damage:</b> Do not expose the imaging unit to direct light for more than 10 minutes. Extended exposure to light may cause print quality problems.</p> <ol style="list-style-type: none"> <li><b>3</b> Reinstall the imaging unit, and then the cartridge.</li> </ol> <p><b>b</b> Resend the print job.</p> <p>Is the printer still printing blank pages?</p>	Go to step 3.	The problem is solved.
<p><b>Step 3</b></p> <p>Replace the imaging unit, and then resend the print job.</p> <p>Is the printer still printing blank pages?</p>	Contact <a href="#">technical support</a> .	The problem is solved.

**Clipped pages or images**

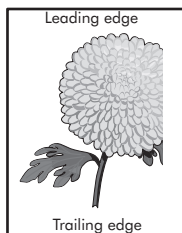
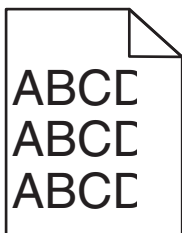



Action	Yes	No
<p><b>Step 1</b></p> <p><b>a</b> Move the width and length guides in the tray to the correct positions for the paper loaded.</p> <p><b>b</b> Resend the print job.</p> <p>Is the page or image clipped?</p>	Go to step 2.	The problem is solved.
<p><b>Step 2</b></p> <p>From the printer control panel, set the paper size and type in the Paper menu to match the paper loaded in the tray.</p> <p>Do the paper size and type match the paper loaded in the tray?</p>	Go to step 3.	<p>Do one or more of the following:</p> <ul style="list-style-type: none"> <li>• Specify the paper size from the tray settings to match the paper loaded in the tray.</li> <li>• Change the paper loaded in the tray to match the paper size specified in the tray settings.</li> </ul>
<p><b>Step 3</b></p> <p><b>a</b> Depending on your operating system, specify the paper size from Printing Preferences or from the Print dialog.</p> <p><b>b</b> Resend the print job.</p> <p>Is the page or image clipped?</p>	Go to step 4.	The problem is solved.
<p><b>Step 4</b></p> <p><b>a</b> Reinstall the imaging unit.</p> <ol style="list-style-type: none"> <li>1 Remove the toner cartridge.</li> <li>2 Remove the imaging unit.</li> </ol> <p><b>Warning—Potential Damage:</b> Do not expose the imaging unit to direct light for more than 10 minutes. Extended exposure to light may cause print quality problems.</p> <ol style="list-style-type: none"> <li>3 Install the imaging unit, and then the cartridge.</li> </ol> <p><b>b</b> Resend the print job.</p> <p>Is the page or image clipped?</p>	Contact <a href="#">technical support</a> .	The problem is solved.

**Shadow images appear on prints**

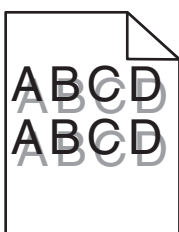

Action	Yes	No
<p><b>Step 1</b> Load paper with the correct paper type and weight in the tray.</p> <p>Is paper with the correct paper type and weight loaded in the tray?</p>	Go to step 2.	Load paper with the correct paper type and weight in the tray.
<p><b>Step 2</b> From the printer control panel, set the paper type and weight in the Paper menu to match the paper loaded in the tray.</p> <p>Is the tray set to the type and weight of the paper loaded?</p>	Go to step 3.	Change the paper loaded in the tray to match the paper type and weight specified in the tray settings.
<p><b>Step 3</b></p> <p><b>a</b> Depending on your operating system, specify the paper type and weight from Printing Preferences or from the Print dialog.</p> <p><b>b</b> Resend the print job.</p> <p>Do shadow images still appear on prints?</p>	Go to step 4.	The problem is solved.
<p><b>Step 4</b> Replace the imaging unit, and then resend the print job.</p> <p>Do shadow images still appear on prints?</p>	Contact <a href="#">technical support</a> .	The problem is solved.

### Gray background on prints

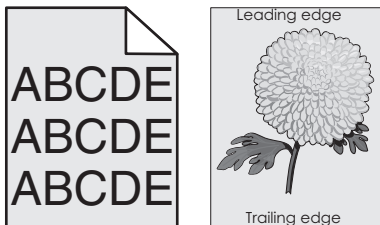

Action	Yes	No
<p><b>Step 1</b></p> <p><b>a</b> From the Quality Menu on the printer control panel, decrease the toner darkness. <b>Note:</b> 8 is the factory default setting.</p> <p><b>b</b> Resend the print job.</p> <p>Did the gray background disappear from the prints?</p>	The problem is solved.	Go to step 2.

Action	Yes	No
<p><b>Step 2</b> Reinstall the imaging unit and the toner cartridge.</p> <ul style="list-style-type: none"> <li><b>a</b> Remove the toner cartridge.</li> <li><b>b</b> Remove the imaging unit.</li> </ul> <p><b>Warning—Potential Damage:</b> Do not expose the imaging unit to direct light for more than 10 minutes. Extended exposure to light can cause print quality problems.</p> <ul style="list-style-type: none"> <li><b>c</b> Install the imaging unit, and then the cartridge.</li> <li><b>d</b> Resend the print job.</li> </ul> <p>Did the gray background disappear from the prints?</p>	The problem is solved.	Go to step 3.
<p><b>Step 3</b> Replace the imaging unit, and then resend the print job.</p> <p>Did the gray background disappear from the prints?</p>	The problem is solved.	Contact <a href="#">technical support</a> .

**Incorrect margins on prints**

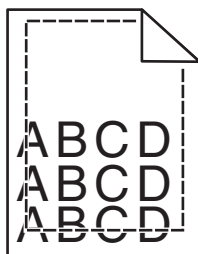

Action	Yes	No
<p><b>Step 1</b></p> <ul style="list-style-type: none"> <li><b>a</b> Move the width and length guides in the tray to the correct positions for the paper size loaded.</li> <li><b>b</b> Resend the print job.</li> </ul> <p>Are the margins correct?</p>	The problem is solved.	Go to step 2.
<p><b>Step 2</b> From the printer control panel, set the paper size in the Paper menu to match the paper loaded in the tray.</p> <p>Does the paper size match the paper loaded in the tray?</p>	Go to step 3.	<p>Do one or more of the following:</p> <ul style="list-style-type: none"> <li>• Specify the paper size from the tray settings to match the paper loaded in the tray.</li> <li>• Change the paper loaded in the tray to match the paper size specified in the tray settings.</li> </ul>

Action	Yes	No
<p><b>Step 3</b></p> <p><b>a</b> Depending on your operating system, specify the paper size from Printing Preferences or from the Print dialog.</p> <p><b>b</b> Resend the print job.</p> <p>Are the margins correct?</p>	The problem is solved.	Contact <a href="#">technical support</a> .

### Paper curl

Action	Yes	No
<p><b>Step 1</b></p> <p>Move the width and length guides in the tray to the correct positions for the size of the paper loaded.</p> <p>Are the width and length guides positioned correctly?</p>	Go to step 2.	Adjust the width and length guides.
<p><b>Step 2</b></p> <p>From the printer control panel, set the paper type and weight in the Paper menu to match the paper loaded in the tray.</p> <p>Do the paper type and weight match the type and weight of the paper in the tray?</p>	Go to step 3.	Specify the paper type and weight from the tray settings to match the paper loaded in the tray.
<p><b>Step 3</b></p> <p><b>a</b> Depending on your operating system, specify the paper type and weight from Printing Preferences or from the Print dialog.</p> <p><b>b</b> Resend the print job.</p> <p>Is the paper still curled?</p>	Go to step 4.	The problem is solved.
<p><b>Step 4</b></p> <p><b>a</b> Remove the paper from the tray, and then turn it over.</p> <p><b>b</b> Resend the print job.</p> <p>Is the paper still curled?</p>	Go to step 5.	The problem is solved.
<p><b>Step 5</b></p> <p><b>a</b> Load paper from a fresh package.</p> <p><b>Note:</b> Paper absorbs moisture due to high humidity. Store paper in its original wrapper until you use it.</p> <p><b>b</b> Resend the print job.</p> <p>Is the paper still curled?</p>	Contact <a href="#">technical support</a> .	The problem is solved.

### Print irregularities

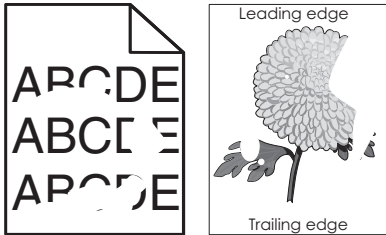

Action	Yes	No
<p><b>Step 1</b></p> <p><b>a</b> Move the width and length guides in the tray to the correct positions for the size of the paper loaded in the tray.</p> <p><b>b</b> Resend the print job.</p> <p>Do print irregularities still appear?</p>	Go to step 2.	The problem is solved.
<p><b>Step 2</b></p> <p>From the printer control panel, set the paper size and type in the Paper menu to match the paper loaded in the tray.</p> <p>Do the printer settings match the type and weight of the paper loaded in the tray?</p>	Go to step 3.	Specify the paper size and type from the tray settings to match the paper loaded in the tray.
<p><b>Step 3</b></p> <p><b>a</b> Depending on your operating system, specify the paper type and weight from Printing Preferences or from the Print dialog.</p> <p><b>b</b> Resend the print job.</p> <p>Do print irregularities still appear?</p>	Go to step 4.	The problem is solved.
<p><b>Step 4</b></p> <p>Check if the paper loaded in the tray has texture or rough finishes.</p> <p>Are you printing on textured or rough paper?</p>	From the printer control panel, set the paper texture in the Paper menu to match the paper loaded in the tray.	Go to step 5.
<p><b>Step 5</b></p> <p><b>a</b> Load paper from a fresh package.</p> <p><b>Note:</b> Paper absorbs moisture due to high humidity. Store paper in its original wrapper until you use it.</p> <p><b>b</b> Resend the print job.</p> <p>Do print irregularities still appear?</p>	Go to step 6.	The problem is solved.
<p><b>Step 6</b></p> <p>Replace the imaging unit, and then resend the print job.</p> <p>Do print irregularities still appear?</p>	Contact <a href="#">technical support</a> or your Dell printer dealer.	The problem is solved.

### Repeating defects appear on prints

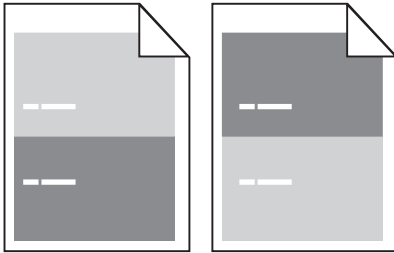

Action	Yes	No
<p><b>Step 1</b>                      Measure the distance between the defects.                      Check for a distance between the defects that equals:</p> <ul style="list-style-type: none"> <li>• 97 mm (3.82 in.)</li> <li>• 47 mm (1.85 in.)</li> <li>• 38 mm (1.5 in.)</li> </ul> <p>Is the distance between defects equal to one of the listed measurements?</p>	<p>Go to step 2.</p>	<p><b>1</b> Check if the distance between the defects equal to 80 mm (3.15 in.)</p> <p><b>2</b> Take note of the distance, and then contact <a href="#">technical support</a> or your Dell printer dealer.</p>
<p><b>Step 2</b>                      Replace the imaging unit, and then resend the print job.                       Do the repeating defects still appear?</p>	<p>Contact <a href="#">technical support</a> or your Dell printer dealer.</p>	<p>The problem is solved.</p>

### Print is too dark

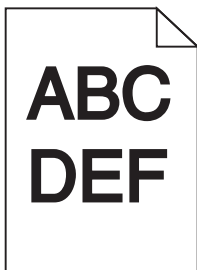

Action	Yes	No
<p><b>Step 1</b></p> <p><b>a</b> From the Quality menu on the printer control panel, reduce the toner darkness.</p> <p><b>Note:</b> 8 is the factory default setting.</p> <p><b>b</b> Resend the print job.</p> <p>Is the print still too dark?</p>	<p>Go to step 2.</p>	<p>The problem is solved.</p>

Action	Yes	No
<p><b>Step 2</b></p> <p><b>a</b> From the printer control panel, set the paper type, texture and weight in the Paper menu to match the paper loaded in the tray.</p> <p><b>b</b> Resend the print job.</p> <p>Is the tray set to the type, texture, and weight of the paper loaded?</p>	Go to step 3.	<p>Do one or more of the following:</p> <ul style="list-style-type: none"> <li>• Specify the paper type, texture, and weight from the tray settings to match the paper loaded in the tray.</li> <li>• Change the paper loaded in the tray to match the paper type, texture and weight specified in the tray settings.</li> </ul>
<p><b>Step 3</b></p> <p><b>a</b> Depending on your operating system, specify the paper type, texture and weight from Printing Preferences or from the Print dialog.</p> <p><b>b</b> Resend the print job.</p> <p>Is the print still too dark?</p>	Go to step 4.	The problem is solved.
<p><b>Step 4</b></p> <p>Check if the paper loaded in the tray has texture or rough finishes.</p> <p>Are you printing on textured or rough paper?</p>	From the printer control panel, change the texture settings in the Paper Texture menu to match the paper you are printing on.	Go to step 5.
<p><b>Step 5</b></p> <p><b>a</b> Load paper from a fresh package.</p> <p><b>Note:</b> Paper absorbs moisture due to high humidity. Store paper in its original wrapper until you use it.</p> <p><b>b</b> Resend the print job.</p> <p>Is the print still too dark?</p>	Go to step 6.	The problem is solved.
<p><b>Step 6</b></p> <p>Replace the imaging unit, and then resend the print job.</p> <p>Is the print still too dark?</p>	Contact <a href="#">technical support</a> .	The problem is solved.

### Print is too light



Action	Yes	No
<p><b>Step 1</b></p> <p><b>a</b> From the Quality menu on the printer control panel, increase the toner darkness.</p> <p><b>Note:</b> 8 is the factory default setting.</p> <p><b>b</b> Resend the print job.</p> <p>Is the print still too light?</p>	Go to step 2.	The problem is solved.
<p><b>Step 2</b></p> <p>From the printer control panel, set the paper type, texture, and weight in the Paper menu to match the paper loaded in the tray.</p> <p>Is the tray set to the type, texture, and weight of the paper loaded?</p>	Go to step 3.	Change the paper type, texture, and weight to match the paper loaded in the tray.
<p><b>Step 3</b></p> <p><b>a</b> Depending on your operating system, specify the paper type, texture, and weight from Printing Preferences or from the Print dialog.</p> <p><b>b</b> Resend the print job.</p> <p>Is the print still too light?</p>	Go to step 4.	The problem is solved.
<p><b>Step 4</b></p> <p>Make sure that the paper has no texture or rough finishes.</p> <p>Are you printing on textured or rough paper?</p>	From the printer control panel, change the texture settings in the Paper Texture menu to match the paper you are printing on.	Go to step 5.
<p><b>Step 5</b></p> <p><b>a</b> Load paper from a fresh package.</p> <p><b>Note:</b> Paper absorbs moisture due to high humidity. Store paper in its original wrapper until you use it.</p> <p><b>b</b> Resend the print job.</p> <p>Is the print still too light?</p>	Go to step 6.	The problem is solved.



Action	Yes	No
<p><b>Step 6</b></p> <p><b>a</b> Redistribute the toner in the imaging unit.</p> <ol style="list-style-type: none"> <li><b>1</b> Remove the toner cartridge, and then the imaging unit.</li> <li><b>2</b> Firmly shake the imaging unit.</li> </ol> <p><b>Warning—Potential Damage:</b> Do not expose the imaging unit to direct light for more than 10 minutes. Extended exposure to light may cause print quality problems.</p> <ol style="list-style-type: none"> <li><b>3</b> Install the imaging unit, and then the cartridge.</li> </ol> <p><b>b</b> Resend the print job.</p> <p>Is the print still too light?</p>	Go to step 7.	The problem is solved.
<p><b>Step 7</b></p> <p>Replace the imaging unit, and then resend the print job.</p> <p>Is the print still too light?</p>	Contact <a href="#">technical support</a> .	The problem is solved.

### Skewed print

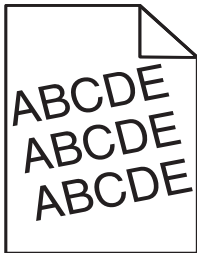

Action	Yes	No
<p><b>Step 1</b></p> <p><b>a</b> Move the width and length guides in the tray to the correct positions for the size of the paper loaded.</p> <p><b>b</b> Resend the print job.</p> <p>Is the print still skewed?</p>	Go to step 2.	The problem is solved.
<p><b>Step 2</b></p> <p><b>a</b> Check if you are printing on a paper that is supported by the tray.</p> <p><b>b</b> Resend the print job.</p> <p>Is the print still skewed?</p>	Contact <a href="#">technical support</a> .	The problem is solved.

### Printer is printing solid black pages



Action	Yes	No
<p><b>Step 1</b></p> <p><b>a</b> Reinstall the imaging unit.</p> <p>    <b>1</b> Remove the toner cartridge, and then the imaging unit.</p> <p>        <b>Warning—Potential Damage:</b> Do not expose the imaging unit to direct light for more than 10 minutes. Extended exposure to light may cause print quality problems.</p> <p>    <b>2</b> Install the imaging unit, and then the cartridge.</p> <p><b>b</b> Resend the print job.</p> <p>Is the printer printing solid black pages?</p>	Go to step 2.	The problem is solved.
<p><b>Step 2</b></p> <p>Replace the imaging unit, and then resend the print job.</p> <p>Is the printer printing solid black pages?</p>	Contact <a href="#">technical support</a> .	The problem is solved.

### Transparency print quality is poor

Action	Yes	No
<p><b>Step 1</b></p> <p>From the printer control panel, set the paper type in the Paper menu to match the paper loaded in the tray.</p> <p>Is the paper type for the tray set to Transparency?</p>	Go to step 2.	Set the paper type to Transparency.
<p><b>Step 2</b></p> <p><b>a</b> Check if you are using a recommended type of transparency.</p> <p><b>b</b> Resend the print job.</p> <p>Is the print quality still poor?</p>	Contact <a href="#">technical support</a> .	The problem is solved.

### Streaked horizontal lines appear on prints

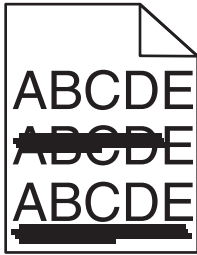

Action	Yes	No
<p><b>Step 1</b></p> <ul style="list-style-type: none"> <li><b>a</b> Depending on your operating system, specify the tray or feeder from Printing Preferences or the Print dialog.</li> <li><b>b</b> Resend the print job.</li> </ul> <p>Do streaked horizontal lines appear on prints?</p>	Go to step 2.	The problem is solved.
<p><b>Step 2</b></p> <p>From the printer control panel, set the paper type and weight in the Paper menu to match the paper loaded in the tray.</p> <p>Do the paper type and weight match the type and weight of the paper in the tray?</p>	Go to step 3.	Change the paper type and weight to match the paper loaded in the tray.
<p><b>Step 3</b></p> <ul style="list-style-type: none"> <li><b>a</b> Load paper from a fresh package.                             <p><b>Note:</b> Paper absorbs moisture due to high humidity. Store paper in its original wrapper until you use it.</p> </li> <li><b>b</b> Resend the print job.</li> </ul> <p>Do streaked horizontal lines appear on prints?</p>	Go to step 4.	The problem is solved.
<p><b>Step 4</b></p> <ul style="list-style-type: none"> <li><b>a</b> Reinstall the imaging unit.                             <ul style="list-style-type: none"> <li><b>1</b> Remove the toner cartridge, and then the imaging unit.                                     <p><b>Warning—Potential Damage:</b> Do not expose the imaging unit to direct light for more than 10 minutes. Extended exposure to light may cause print quality problems.</p> </li> <li><b>2</b> Install the imaging unit, and then the cartridge.</li> </ul> </li> <li><b>b</b> Resend the print job.</li> </ul> <p>Do streaked horizontal lines appear on prints?</p>	Go to step 5.	The problem is solved.
<p><b>Step 5</b></p> <p>Replace the imaging unit, and then resend the print job.</p> <p>Do streaked horizontal lines appear on prints?</p>	Contact <a href="#">technical support</a> .	The problem is solved.

### Streaked vertical lines appear on prints

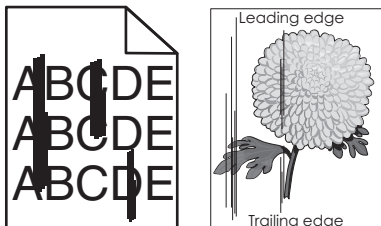

Action	Yes	No
<p><b>Step 1</b></p> <p><b>a</b> Depending on your operating system, specify the paper type, texture, and weight from Printing Preferences or from the Print dialog.</p> <p><b>b</b> Resend the print job.</p> <p>Do streaked vertical lines appear on prints?</p>	Go to step 2.	The problem is solved.
<p><b>Step 2</b></p> <p>From the printer control panel, set the paper texture, type, and weight in the Paper menu to match the paper loaded in the tray.</p> <p>Do the paper texture, type, and weight match the paper in the tray?</p>	Go to step 3.	<p>Do one or more of the following:</p> <ul style="list-style-type: none"> <li>Specify the paper texture, type, and weight from the tray settings to match the paper loaded in the tray.</li> <li>Change the paper loaded in the tray to match the paper texture, type, and weight specified in the tray settings.</li> </ul>
<p><b>Step 3</b></p> <p><b>a</b> Load paper from a fresh package.</p> <p><b>Note:</b> Paper absorbs moisture due to high humidity. Store paper in its original wrapper until you use it.</p> <p><b>b</b> Resend the print job.</p> <p>Do streaked vertical lines appear on prints?</p>	Go to step 4.	The problem is solved.
<p><b>Step 4</b></p> <p><b>a</b> Reinstall the imaging unit.</p> <p><b>1</b> Remove the toner cartridge, and then the imaging unit.</p> <p><b>Warning—Potential Damage:</b> Do not expose the imaging unit to direct light for more than 10 minutes. Extended exposure to light may cause print quality problems.</p> <p><b>2</b> Install the imaging unit, and then the cartridge.</p> <p><b>b</b> Resend the print job.</p> <p>Do streaked vertical lines appear on prints?</p>	Go to step 5.	The problem is solved.

Action	Yes	No
<p><b>Step 5</b>                      Replace the imaging unit, and then resend the print job.</p> <p>Do streaked vertical lines appear on prints?</p>	<p>Contact <a href="#">technical support</a> or your Dell printer dealer.</p>	<p>The problem is solved.</p>

### Horizontal voids appear on prints

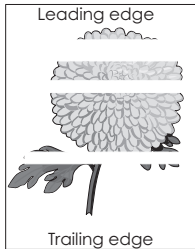

Action	Yes	No
<p><b>Step 1</b>                      a Make sure your software program is using a correct fill pattern.                      b Resend the print job.</p> <p>Do horizontal voids appear on prints?</p>	<p>Go to step 2.</p>	<p>The problem is solved.</p>
<p><b>Step 2</b>                      a Load the specified tray or feeder with a recommended type of paper.                      b Resend the print job.</p> <p>Do horizontal voids appear on prints?</p>	<p>Go to step 3.</p>	<p>The problem is solved.</p>
<p><b>Step 3</b>                      a Redistribute the toner in the imaging unit.                      1 Remove the toner cartridge, and then the imaging unit.                      2 Firmly shake the imaging unit.  <b>Warning—Potential Damage:</b> Do not expose the imaging unit to direct light for more than 10 minutes. Extended exposure to light may cause print quality problems.                      3 Reinstall the imaging unit, and then the cartridge.                      b Resend the print job.</p> <p>Do horizontal voids appear on prints?</p>	<p>Go to step 4.</p>	<p>The problem is solved.</p>
<p><b>Step 4</b>                      Replace the imaging unit, and then resend the print job.</p> <p>Do horizontal voids appear on prints?</p>	<p>Contact <a href="#">technical support</a>.</p>	<p>The problem is solved.</p>

### Vertical voids appear on prints

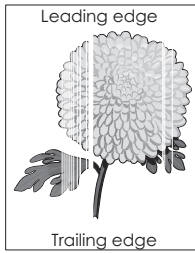

Action	Yes	No
<p><b>Step 1</b></p> <ul style="list-style-type: none"> <li><b>a</b> Make sure your software program is using a correct fill pattern.</li> <li><b>b</b> Resend the print job.</li> </ul> <p>Do vertical voids appear on prints?</p>	Go to step 2.	The problem is solved.
<p><b>Step 2</b></p> <ul style="list-style-type: none"> <li><b>a</b> From the printer control panel, set the paper type and weight in the Paper menu to match the paper loaded in the tray.</li> <li><b>b</b> Resend the print job.</li> </ul> <p>Do vertical voids appear on prints?</p>	Go to step 3.	The problem is solved.
<p><b>Step 3</b></p> <p>Check if you are using a recommended type of paper.</p> <ul style="list-style-type: none"> <li><b>a</b> Load the indicated tray or feeder with a recommended type of paper.</li> <li><b>b</b> Resend the print job.</li> </ul> <p>Do vertical voids appear on prints?</p>	Go to step 4.	The problem is solved.
<p><b>Step 4</b></p> <ul style="list-style-type: none"> <li><b>a</b> Redistribute the toner in the imaging unit.                             <ol style="list-style-type: none"> <li><b>1</b> Remove the toner cartridge, and then the imaging unit.</li> <li><b>2</b> Firmly shake the imaging unit.</li> </ol> <p><b>Warning—Potential Damage:</b> Do not expose the imaging unit to direct light for more than 10 minutes. Extended exposure to light may cause print quality problems.</p> <ol style="list-style-type: none"> <li><b>3</b> Reinstall the imaging unit, and then the cartridge.</li> </ol> </li> <li><b>b</b> Resend the print job.</li> </ul> <p>Do vertical voids appear on prints?</p>	<p>Contact <a href="#">technical support</a>.</p> <p><b>Note:</b> The laser scanning unit may be defective.</p>	The problem is solved.

### Toner specks appear on prints

Action	Yes	No
Replace the imaging unit, and then resend the print job.  Do toner specks appear on prints?	Contact <a href="#">technical support</a> .	The problem is solved.

### Toner rubs off

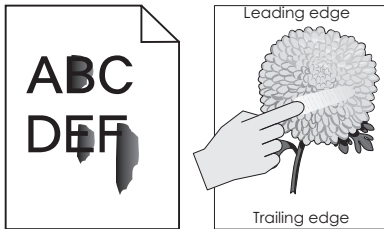

Action	Yes	No
<b>Step 1</b> From the Paper menu on the printer control panel, check the paper type, texture, and weight.  Do the paper type, texture, and weight match the paper loaded in the tray?	Go to step 2.	Specify the paper type, texture, and weight from the tray settings to match the paper loaded in the tray.
<b>Step 2</b> Resend the print job.  Does the toner still rub off?	Contact <a href="#">technical support</a> or your Dell printer dealer.	The problem is solved.

### Uneven print density

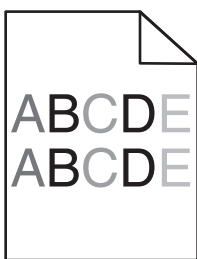

Action	Yes	No
Replace the imaging unit, and then resend the print job.  Is the print density uneven?	Contact <a href="#">technical support</a> .	The problem is solved.

## Embedded Web Server does not open

Action	Yes	No
<p><b>Step 1</b></p> <p><b>a</b> Turn on the printer.</p> <p><b>b</b> Open a Web browser, and then type the printer IP address.</p> <p><b>c</b> Press <b>Enter</b>.</p> <p>Does the Embedded Web Server open?</p>	The problem is solved.	Go to step 2.
<p><b>Step 2</b></p> <p>Make sure the printer IP address is correct.</p> <p><b>a</b> View the printer IP address:</p> <ul style="list-style-type: none"> <li>• From the TCP/IP section in the Network/Ports menu</li> <li>• By printing a network setup page or menu settings page, and then finding the TCP/IP section</li> </ul> <p><b>Note:</b> An IP address appears as four sets of numbers separated by periods, such as 123.123.123.123.</p> <p><b>b</b> Open a Web browser, and then type the IP address.</p> <p><b>Note:</b> Depending on the network settings, you may need to type “<b>https://</b>” instead of “<b>http://</b>” before the printer IP address to access the Embedded Web Server.</p> <p><b>c</b> Press <b>Enter</b>.</p> <p>Does the Embedded Web Server open?</p>	The problem is solved.	Go to step 3.
<p><b>Step 3</b></p> <p>Check if the network is working.</p> <p><b>a</b> Print a network setup page.</p> <p><b>b</b> Check the first section of the network setup page and confirm that the status is Connected.</p> <p><b>Note:</b> If the status is Not Connected, then the connection may be intermittent, or the network cable may be defective. Contact your system support person for a solution, and then print another network setup page.</p> <p><b>c</b> Open a Web browser, and then type the printer IP address.</p> <p><b>d</b> Press <b>Enter</b>.</p> <p>Does the Embedded Web Server open?</p>	The problem is solved.	Go to step 4.
<p><b>Step 4</b></p> <p>Check if the cable connections to the printer and print server are secure.</p> <p><b>a</b> Connect the cables properly. For more information, see the setup documentation that came with the printer.</p> <p><b>b</b> Open a Web browser, and then type the printer IP address.</p> <p><b>c</b> Press <b>Enter</b>.</p> <p>Does the Embedded Web Server open?</p>	The problem is solved.	Go to step 5.



Action	Yes	No
<p><b>Step 5</b>                      Temporarily disable the Web proxy servers.                      Proxy servers may block or restrict you from accessing certain Web sites including the Embedded Web Server.</p> <p>Does the Embedded Web Server open?</p>	<p>The problem is solved.</p>	<p>Contact your system support person.</p>

## Contacting technical support

When you call technical support, describe the problem you are experiencing, the message on the printer display, and the troubleshooting steps you have already taken to find a solution.

You need to know your printer model type and the service tag number or express service code. For more information, see the label on the inside top front cover or at the back of the printer. The service tag number is also listed on the menu settings page.

For more information, check the Dell support Web site at [www.dell.com/support/printers](http://www.dell.com/support/printers).

# Appendix

## Dell Technical Support Policy

Technician-assisted technical support requires the cooperation and participation of the customer in the troubleshooting process and provides for restoration of the Operating System, application software and hardware drivers to the original default configuration as shipped from Dell, as well as the verification of appropriate functionality of the printer and all Dell-installed hardware. In addition to this technician assisted technical support, online technical support is available at Dell Support. Additional technical support options may be available for purchase.

Dell provides limited technical support for the printer and any Dell-installed software and peripherals. Support for third-party software and peripherals is provided by the original manufacturer, including those purchased and/or installed through Software & Peripherals (DellWare), ReadyWare, and Custom Factory Integration (CFI/DellPlus).

## Contacting Dell

You can access Dell Support at [www.dell.com/support/printers](http://www.dell.com/support/printers).

You can contact Dell electronically using the following addresses:

- World Wide Web

[www.dell.com/](http://www.dell.com/)

[www.dell.com/ap/](http://www.dell.com/ap/) (Asian/Pacific countries only)

[www.dell.com/jp/](http://www.dell.com/jp/) (Japan only)

[www.euro.dell.com](http://www.euro.dell.com) (Europe only)

[www.dell.com/la/](http://www.dell.com/la/) (Latin American and Caribbean countries)

[www.dell.ca](http://www.dell.ca) (Canada only)

- Anonymous file transfer protocol (FTP)

[ftp.dell.com](ftp://ftp.dell.com)

Log in as user: anonymous, and use your email address as your password.

- Electronic Support Service

[mobile\\_support@us.dell.com](mailto:mobile_support@us.dell.com)

[support@us.dell.com](mailto:support@us.dell.com)

[la-techsupport@dell.com](mailto:la-techsupport@dell.com) (Latin America and Caribbean countries only)

[apsupport@dell.com](mailto:apsupport@dell.com) (Asian/Pacific countries only)

[support.jp.dell.com](mailto:support.jp.dell.com) (Japan only)

[support.euro.dell.com](mailto:support.euro.dell.com) (Europe only)

- Electronic Quote Service

[apmarketing@dell.com](mailto:apmarketing@dell.com) (Asian/Pacific countries only)

[sales\\_canada@dell.com](mailto:sales_canada@dell.com) (Canada only)

## **Warranty and Return Policy**

Dell Inc. (“Dell”) manufactures its hardware products from parts and components that are new or equivalent to new in accordance with industry-standard practices. For information about the Dell warranty for your printer, refer to the *Product Information Guide*.

# Index

## A

- accessing Status Monitor Center 93
- accessing the controller board 14
- accessing the remote control panel
  - Embedded Web Server 93
- Active NIC menu 59
- adding hardware options
  - print driver 20
- adjusting Sleep mode 81
- adjusting toner darkness 46
- AirPrint
  - using 47
- AppleTalk menu 63
- assigning custom paper types 36
- attaching cables 18
- available internal options 14
- avoiding jams 43
- avoiding paper jams 97

## B

- Bin full. Remove paper. 108

## C

- cables
  - Ethernet 18
  - parallel 18
  - USB 18
- canceling a print job
  - from a computer 48
  - from the printer control panel 48
- Cannot collate large document [37] 108
- Cannot defrag flash memory [37] 108
- cannot open Embedded Web Server 144
- card stock
  - loading, multipurpose feeder 32
  - tips 41
- Cartridge low [88.xy] 108
- Cartridge nearly low [88.xy] 108
- Cartridge very low, [x] estimated pages remain [88.xy] 108
- Change [paper source] to [custom string]. Load [orientation]. 109
- Change [paper source] to [custom type name]. Load [orientation]. 109

- Change [paper source] to [paper size]. Load [orientation]. 109
- Change [paper source] to [paper type] [paper size]. Load [orientation]. 109
- checking an unresponsive printer 116
- checking the status of parts and supplies 86
- cleaning
  - exterior of the printer 86
- cleaning the printer 86
- Close front door 109
- Complex page may misprint [39] 109
- confidential data
  - information on securing 85
- configuration information
  - wireless network 21
- configurations
  - printer 9
- Configure MP menu 53
- configuring
  - multiple printers 95
  - supply notifications, imaging unit 94
  - supply notifications, toner cartridge 94
- configuring custom paper types 36
- configuring supply notifications 94
- connecting to a wireless network
  - using Personal Identification Number (PIN) method 22
  - using Push Button Configuration (PBC) method 22
  - using the Embedded Web Server 24
- conservation settings
  - Eco-Mode 80
  - Hibernate Timeout 82
  - Schedule Power Modes 82
  - Sleep mode 81
- contacting technical support 145
- control panel, printer
  - buttons 11
  - indicator light 11, 12
  - Sleep button light 12
  - using 11

- controller board
  - accessing 14
- creating the printer control panel PIN 96
- custom paper type
  - assigning 36
  - configuring 36
- Custom Types menu 57

## D

- Default Source menu 49
- Defective flash memory [51] 110
- Dell Mobile Print
  - using 47
- display troubleshooting
  - printer display is blank 118
- documents, printing
  - from Macintosh 46
  - from Windows 46

## E

- Eco-Mode setting 80
- Embedded Web Server
  - accessing 12
  - accessing the remote control panel 93
  - copying settings to other printers 95
  - functions 12
  - problem accessing 144
  - using 12
- Embedded Web Server—Security: Administrator's Guide
  - where to find 85
- envelopes
  - loading, multipurpose feeder 32
  - tips on using 41
- environmental settings
  - Eco-Mode 80
  - Hibernate Timeout 82
  - Schedule Power Modes 82
  - Sleep mode 81
- erasing non-volatile memory 85
- erasing volatile memory 85
- Ethernet network
  - preparing to set up for Ethernet printing 20
- Ethernet port 18

- Ethernet setup
  - preparing for an 20
- exterior of the printer
  - cleaning 86
- F**
- factory defaults, restoring 95
- finding more information about the printer 7
- Finishing menu 73
- Flash memory full [52] 110
- Flash memory unformatted [53] 110
- font sample list, printing 48
- G**
- green settings
  - Eco-Mode 80
  - Hibernate Timeout 82
  - Schedule Power Modes 82
- H**
- hardware options, adding
  - print driver 20
- Hibernate Timeout
  - setting 82
- I**
- imaging unit
  - replacing 89
- Imaging unit low [84.xy] 110
- Imaging unit nearly low [84.xy] 110
- Imaging unit very low, [x] estimated pages remain [84.xy] 110
- Insert tray [x] 111
- installing
  - optional tray 17
- installing an optional card 15
- installing optional tray 17
- installing printer 19
- installing software
  - Local Printer Settings Utility 19
- IPv6 menu 62
- J**
- Jam, front door [20y.xx] 99
- Jam, MP feeder [250.xx] 106
- Jam, pull tray 1. Push down blue flap. [23y.xx] 104
- Jam, rear door [20y.xx] 102
- Jam, standard bin [20y.xx] 103
- Jam, tray [x] [24y.xx] 106
- jams
  - accessing 98
  - avoiding 97
  - understanding messages 98
- jams, clearing
  - behind front door 99
  - behind rear door 102
  - in duplex area 104
  - in standard bin 103
  - in Tray 1 106
  - in Tray 2 106
  - Multipurpose feeder 106
- L**
- labels, paper
  - tips on using 42
- letterhead
  - loading, multipurpose feeder 32
  - tips on using 42
- linking trays 35
- Load [paper source] with [custom string] [orientation] 111
- Load [paper source] with [custom type name] [orientation] 111
- Load [paper source] with [paper size] [orientation] 111
- Load [paper source] with [paper type] [paper size] [orientation] 111
- Load MP feeder with [custom string] [orientation] 112
- Load MP feeder with [custom type name] [orientation] 112
- Load MP feeder with [paper size] [orientation] 112
- Load MP feeder with [paper type] [paper size] [orientation] 112
- loading
  - multipurpose feeder 32
  - trays 27
- loading the optional tray 27
- loading the standard tray 27
- Local Printer Settings Utility
  - installing 19
  - using 13
- lock, security 84
- M**
- managing printer messages 93
- memory
  - types installed on printer 84
- Memory full [38] 113
- Memory low, no Resource Save [35] 113
- menu settings
  - loading on multiple printers 95
- menu settings page
  - printing 24
- menus
  - Active NIC 59
  - AppleTalk 63
  - Configure MP 53
  - Custom Types 57
  - Default Source 49
  - Finishing 73
  - in Local Printer Settings Utility 13
  - IPv6 62
  - list of 49
  - Network [x] 59
  - Network Card 60
  - Network Reports 60
  - Paper Loading 56
  - Paper Size/Type 50
  - Paper Texture 53
  - Paper Weight 55
  - PCL Emul 77
  - PostScript 76
  - Quality 75
  - Reports 58
  - Security Audit Log 66
  - Set Date and Time 67
  - Setup 72
  - SMTP Setup menu 65
  - Standard Network 59
  - Standard USB 64
  - Substitute Size 53
  - TCP/IP 61
  - Universal Setup 57
  - Utilities 76
  - Wireless 63
  - XPS 76
- menus list 49
- mobile device
  - printing from 47
- moving the printer 8, 92
- multipurpose feeder
  - loading 32
- N**
- Network [x] menu 59
- Network Card menu 60

Network error, port [x] [54] 113  
Network error, standard port [54] 113  
Network Reports menu 60  
network setup page  
  printing 25  
Non-Dell [supply type], see User's Guide [33.xy] 113  
non-volatile memory 84  
  erasing 85  
number of remaining pages  
  estimate 87

## O

optional card  
  installing 15  
optional tray  
  installing 17  
  loading 27  
options  
  memory cards 14  
ordering supplies  
  using Printer Home 87

## P

paper  
  characteristics 38  
  letterhead 39  
  loading, multipurpose feeder 32  
  preprinted forms 39  
  recycled 40  
  selecting 39  
  storing 43  
  unacceptable 39, 40  
  Universal size setting 26  
paper feed troubleshooting  
  message remains after jam is cleared 121  
paper jams  
  avoiding 97  
paper jams, clearing  
  behind front door 99  
  behind rear door 102  
  in duplex area 104  
  in standard bin 103  
  in Tray 1 106  
  in Tray 2 106  
  Multipurpose feeder 106  
Paper Loading menu 56

paper messages  
  Jam, pull tray 1. Push down blue flap. [23y.xx] 104  
paper size  
  setting 26  
Paper Size/Type menu 50  
paper sizes  
  supported by the printer 43  
paper stop, using 27  
Paper Texture menu 53  
Paper too short [34] 114  
paper type  
  setting 26  
paper types  
  duplex support 44  
  supported by printer 44  
  where to load 44  
Paper Weight menu 55  
parallel port 18  
Parallel port disabled [56] 114  
parts  
  checking status 86  
PCL Emul menu 77  
Personal Identification Number method  
  using 22  
PostScript menu 76  
preparing to set up the printer on an Ethernet network 20  
print driver  
  hardware options, adding 20  
print irregularities 133  
print job  
  canceling from the printer control panel 48  
  canceling, from computer 48  
print quality troubleshooting  
  blank pages 127  
  characters have jagged edges 126  
  clipped pages or images 128  
  gray background on prints 130  
  horizontal voids appear on prints 141  
  print irregularities 133  
  print is too dark 134  
  print is too light 136  
  printer is printing solid black pages 138  
  repeating print defects appear on prints 134  
  shadow images appear on prints 129

skewed print 137  
streaked horizontal lines appear on prints 139  
streaked vertical lines 140  
toner rubs off 143  
toner specks appear on prints 143  
transparency print quality is poor 138  
uneven print density 143  
white streaks 142  
print troubleshooting  
  incorrect characters print 125  
  incorrect margins on prints 131  
  jammed pages are not reprinted 121  
  job prints from wrong tray 124  
  job prints on wrong paper 124  
  jobs do not print 122  
  Large jobs do not collate 125  
  paper curl 132  
  paper frequently jams 120  
  print job takes longer than expected 123  
  printing slows down 123  
  tray linking does not work 125  
  unexpected page breaks occur 126  
printer 19  
  configurations 9  
  minimum clearances 8  
  moving 8, 92  
  selecting a location 8  
  shipping 92  
printer configurations  
  basic model 9  
  configured model 9  
printer control panel  
  buttons 11  
  factory defaults, restoring 95  
  indicator light 11, 12  
  Sleep button light 12  
  using 11  
printer control panel PIN  
  creating 96  
printer information  
  where to find 7  
printer is printing blank pages 127  
printer messages  
  Bin full. Remove paper. 108  
  Cannot collate large document [37] 108

- Cannot defrag flash memory
    - [37] 108
  - Cartridge low [88.xy] 108
  - Cartridge nearly low [88.xy] 108
  - Cartridge very low, [x] estimated pages remain [88.xy] 108
  - Change [paper source] to [custom string]. Load [orientation]. 109
  - Change [paper source] to [custom type name]. Load [orientation]. 109
  - Change [paper source] to [paper size]. Load [orientation]. 109
  - Change [paper source] to [paper type] [paper size]. Load [orientation]. 109
  - Close front door 109
  - Complex page may misprint [39] 109
  - Defective flash memory [51] 110
  - Flash memory full [52] 110
  - Flash memory unformatted [53] 110
  - Imaging unit low [84.xy] 110
  - Imaging unit nearly low [84.xy] 110
  - Imaging unit very low, [x] estimated pages remain [84.xy] 110
  - Insert tray [x] 111
  - Jam, front door [20y.xx] 99
  - Jam, MP feeder [250.xx] 106
  - Jam, rear door [20y.xx] 102
  - Jam, standard bin [20y.xx] 103
  - Jam, tray [x] [24y.xx] 106
  - Load [paper source] with [custom string] [orientation] 111
  - Load [paper source] with [custom type name] [orientation] 111
  - Load [paper source] with [paper size] [orientation] 111
  - Load [paper source] with [paper type] [paper size] [orientation] 111
  - Load MP feeder with [custom string] [orientation] 112
  - Load MP feeder with [custom type name] [orientation] 112
  - Load MP feeder with [paper size] [orientation] 112
  - Load MP feeder with [paper type] [paper size] [orientation] 112
  - managing 93
  - Memory full [38] 113
  - Memory low, no Resource Save [35] 113
  - Network error, port [x] [54] 113
  - Network error, standard port [54] 113
  - Non-Dell [supply type], see User's Guide [33.xy] 113
  - Paper too short [34] 114
  - Parallel port disabled [56] 114
  - Printer restart. Check last job. 114
  - Rear USB port disabled [56] 114
  - Reinstall missing or unresponsive cartridge [31.xy] 115
  - Reinstall missing or unresponsive imaging unit [31.xy] 115
  - Replace cartridge, 0 estimated pages remain [88.xy] 115
  - Replace cartridge, printer region mismatch [42.xy] 115
  - Replace imaging unit, 0 estimated pages remain [84.xy] 115
  - Replace unsupported cartridge [32.xy] 115
  - Replace unsupported imaging unit [32.xy] 116
  - Too many trays. Remove some. [58] 116
  - printer options troubleshooting
    - internal option is not detected 118
    - tray problems 119
  - printer problems, solving basic 116
  - Printer restart. Check last job. 114
  - printer security
    - information on 85
  - printing
    - font sample list 48
    - from a mobile device using AirPrint 47
    - from a mobile device using Dell Mobile Print 47
    - from Macintosh 46
    - from Windows 46
    - menu settings page 24
    - network setup page 25
    - printing a document 46
    - publications
      - where to find 7
  - Push Button Configuration method using 22
- ## Q
- Quality menu 75
- ## R
- Rear USB port disabled [56] 114
  - recycled paper
    - using 40
  - recycling
    - Dell products 83
  - Reinstall missing or unresponsive cartridge [31.xy] 115
  - Reinstall missing or unresponsive imaging unit [31.xy] 115
  - remote control panel
    - using Embedded Web Server 93
  - repeating print defects appear on prints 134
  - Replace cartridge, 0 estimated pages remain [88.xy] 115
  - Replace cartridge, printer region mismatch [42.xy] 115
  - Replace imaging unit, 0 estimated pages remain [84.xy] 115
  - Replace unsupported cartridge [32.xy] 115
  - Replace unsupported imaging unit [32.xy] 116
  - replacing
    - imaging unit 89
    - toner cartridge 88
  - reports
    - viewing 94
  - Reports menu 58
  - restoring factory default settings 95
- ## S
- safety information 5, 6
  - Schedule Power Modes
    - using 82
  - Security Audit Log menu 66
  - security lock 84
  - selecting a location for the printer 8
  - selecting paper 39
  - Set Date and Time menu 67
  - setting
    - paper size 26
    - paper type 26
    - TCP/IP address 61
    - Universal paper size 26

- setting Hibernate Timeout 82
- Setup menu 72
- shipping the printer 92
- Sleep mode
  - adjusting 81
- SMTP Setup menu 65
- software
  - Status Messenger 93
  - Status Monitor Center 93
  - Supplies Ordering Utility 87
- standard bin, using 27
- Standard Network menu 59
- standard tray
  - loading 27
- Standard USB menu 64
- statement of volatility 84
- Status Monitor Center
  - accessing 93
- storing
  - paper 43
  - supplies 87
- streaked horizontal lines appear on prints 139
- streaked vertical lines appear on prints 140
- streaks appear 142
- Substitute Size menu 53
- supplies
  - checking status 86
  - ordering 87
  - storing 87
- Supplies Ordering Utility
  - ordering supplies 87
- supply notifications
  - configuring 94
- supported paper sizes 43
- supported paper types and weights 44

## T

- TCP/IP menu 61
- tips
  - card stock 41
  - letterhead 42
  - on using envelopes 41
  - on using labels 42
  - transparencies 42
- tips on using envelopes 41
- toner cartridge
  - replacing 88
- toner darkness
  - adjusting 46

- Too many trays. Remove some. [58] 116
- transparencies
  - loading, multipurpose feeder 32
  - tips 42
- trays
  - linking 35
  - loading 27
  - unlinking 35
- troubleshooting
  - cannot open Embedded Web Server 144
  - checking an unresponsive printer 116
  - contacting technical support 145
  - solving basic printer problems 116
- troubleshooting, display
  - printer display is blank 118
- troubleshooting, paper feed
  - message remains after jam is cleared 121
- troubleshooting, print
  - incorrect characters print 125
  - incorrect margins on prints 131
  - jammed pages are not reprinted 121
  - job prints from wrong tray 124
  - job prints on wrong paper 124
  - jobs do not print 122
  - Large jobs do not collate 125
  - paper curl 132
  - paper frequently jams 120
  - print job takes longer than expected 123
  - printing slows down 123
  - tray linking does not work 125
  - unexpected page breaks occur 126
- troubleshooting, print quality
  - blank pages 127
  - characters have jagged edges 126
  - clipped pages or images 128
  - gray background on prints 130
  - horizontal voids appear on prints 141
  - print irregularities 133
  - print is too dark 134
  - print is too light 136
  - printer is printing solid black pages 138

- repeating print defects appear on prints 134
- shadow images appear on prints 129
- skewed print 137
- streaked horizontal lines appear on prints 139
- streaked vertical lines 140
- toner rubs off 143
- toner specks appear on prints 143
- transparency print quality is poor 138
- uneven print density 143
- white streaks on a page 142
- troubleshooting, printer options
  - internal option is not detected 118
- tray problems 119

## U

- unacceptable paper 39
- uneven print density 143
- Universal paper size
  - setting 26
- Universal Setup menu 57
- unlinking trays 35
- USB port 18
- using
  - Wireless Setup Assistant 23
- using Schedule Power Modes 82
- using the Embedded Web Server 12
- using Wireless Setup Utility 23
- Utilities menu 76

## V

- vertical voids appear 142
- viewing
  - reports 94
- voids appear 142
- volatile memory 84
  - erasing 85
- volatility
  - statement of 84

## W

- Wireless menu 63
- wireless network
  - configuration information 21



wireless network setup  
  using the Embedded Web  
  Server 24

Wireless Setup Assistant  
  using 23

Wireless Setup Utility  
  using 23

## **X**

XPS menu 76